

H5A MULTISENSOR CAMERA

9 MP

12 MP

15 MP

20 MP

24 MP

32 MP

The Avigilon H5A Multisensor camera helps ensure your site is covered from all angles by combining Next-Generation Video Analytics and three or four adjustable sensors into one powerful solution. Monitor virtually any area in all lighting conditions with up to 360-degree views from a single camera. This makes the H5A Multisensor perfect for securing wide areas, including outdoor building corners, parking lots, crossroads, as well as indoor areas with high ceilings, long corridors and hallway intersections.



FEATURES



NEXT-GENERATION VIDEO ANALYTICS

Detects more objects with expanded object classifications and greater accuracy for faster responses, even in crowded scenes.



IMPACT, WATER, DUST & CORROSION PROTECTION

Protects against impact, water, windblown dust and a degree of corrosion with IK10, IP66/67, NEMA Type 4X and TS2 ratings.



ONVIF® COMPLIANT

ONVIF Profile S and T compliance enables easy integration with existing ONVIF infrastructures. Profile G compliance supports search, playback and retrieval of recordings on the edge, while Profile M allows for cross-functionality with third-party analytic solutions.



VARIFOCAL LENSES

Enables you to customize the field of view to optimally protect your site, while lens distortion correction provides a seamless viewing experience.



FIPS 140-2 COMPLIANT WITH INTEGRATED TPM

Meets the high data security standards required by federal government agencies and heavily regulated enterprises with FIPS-compliant cryptography support, integrated TPM and Secure Boot.



HIGH-QUALITY IMAGES IN ALL LIGHTING

Sees clearly in the most challenging lighting conditions with faster frame rates, improved Wide Dynamic Range and optional IR illumination.

ONVIF is a trademark of Onvif, Inc.



Preliminary Specifications - Subject to Change



SPECIFICATIONS

IMAGE PERFORMANCE		3.0 MP	5.0 MP	4K (8.0 MP)
Image Sensor		1/2.8" CMOS		1/2.8" CMOS
Active Pixels		1920 (H) x 1080 (V) (16:9) 2048 (H) x 1536 (V) (4:3)	2560 x 1440 (16:9) 2592 x 1944 (4:3)	3840 x 2160 (16:9) 2880 x 2160 (4:3)
3 x Image Sensor, Max Resolution (per image sensor)		5760 (H) x 1080 (V) (16:9) 6144 (H) x 1536 (V) (4:3)	7680 x 1440 (16:9) 7776 x 1944 (4:3)	11520 x 2160 (16:9) 8640 x 2160 (4:3)
4 x Image Sensor, Max Resolution (per image sensor)		7680 (H) x 1080 (V) (16:9) 8192 (H) x 1536 (V) (4:3)	10240 x 1440 (16:9) 10368 x 1944 (4:3)	15360 x 2160 (16:9) 11520 x 2160 (4:3)
Sensor Aspect Ratio		4:3	4:3	16:9
IR Illumination - Optional (high power 850 nm LEDs) ¹		30 m (98 ft) maximum distance at 0 lux when camera is mounted at 4 m (13 ft) off the ground, full tele TBD m, full wide TBD m		
Minimum Illumination		0.020 lux (F1.5) in color mode 0.018 lux (F1.5) in mono mode 0 lux with optional IR illuminator		0.020 lux (F1.5) in color mode 0.016 lux (F1.5) in mono mode 0 lux with optional IR illuminator
Dynamic Range	WDR On	120 dB, true WDR, dual exposure		
	WDR Off	80 dB		
3D Noise Reduction Filter		Yes		
Image Rate-Analytics Enabled on All Sensors²:				
3 x Image Sensor (60 Hz, 50 Hz)		30 / 25 fps	30 / 25 fps	24 / 20 fps
4 x Image Sensor (60 Hz, 50 Hz)		30 / 25 fps	24 / 25 fps	17 / 16 fps
Image Rate-High Framerate Mode³:				
3 x Image Sensor (60 Hz, 50 Hz)		60 / 50 fps	40 / 33 fps	30 / 25 fps
4 x Image Sensor (60 Hz, 50 Hz)		40 / 33 fps	24 / 25 fps	20 / 20 fps

¹ The IR intensity is based on supplied PoE power.

² Full Feature Mode: Analytics, WDR, and Lens Distortion Correction enabled with H.265. Image Rotation at Edge will result in lower frame rates.

³ High Frame Rate Mode: Analytics and WDR disabled with H.265.

IMAGE CONTROL	
Image Compression Method	H.264 HDSM SmartCodec, H.265 HDSM SmartCodec, Motion JPEG
Streaming	Multi-stream H.264, Multi-stream H.265, Motion JPEG
Motion Detection	Selectable sensitivity and threshold
Electronic Shutter Control	Automatic, Manual (1/7.5 to 1/8000 sec)
Iris Control	Fixed
Day/Night Control	Automatic, Manual
Flicker Control	60 Hz, 50 Hz
White Balance	Automatic, Manual
Backlight Compensation	Adjustable
Privacy Zones	Up to 64 zones
Removable Privacy Zones	Up to 64 zones
Lens Distortion Correction	Fixed
Camera Image Rotation	Each head independent

LENS (PER IMAGE SENSOR)	3.0 MP	5.0 MP	4K (8.0 MP)
Lens and Horizontal Field of View Based on Aspect Ratio	53° - 97° (16:9) 53° - 99° (4:3)		43° - 109° (16:9) 58° - 76° (4:3)

LENS (PER IMAGE SENSOR)	3.0 MP	5.0 MP	4K (8.0 MP)
Lens and Vertical Field of View Based on Aspect Ratio	29° - 50° (16:9) 39° - 69° (4:3)		32° - 55° (16:9) 32° - 55° (4:3)
Aperture Range	F1.5 - F1.9		
Control	Fixed Iris, Remote Focus and Zoom		

NETWORK	
Network	Gigabit Ethernet, 100BASE-TX, 1000BASE-TX
Cabling Type	CAT5E
Connector	RJ-45
API	ONVIF® compliance Profile S, T, M, and G (www.onvif.org)
Security	Signed and encrypted firmware, password protection, HTTPS encryption, digest authentication, WS authentication, user access log, 802.1x port based authentication, TLS1.3, FIPS140-2 Level 3 via onboard TPM
Secure Boot	Yes
Protocol	IPv4, IPv6, HTTP, HTTPS, SOAP, DNS, NTP, RTSP, RTCP, RTP, TCP, UDP, IGMPv2, ICMP, DHCP, Zeroconf, ARP, HSTS
Streaming Protocols	RTP/UDP, RTP/UDP multicast, RTP/RTSP/TCP, RTP/RTSP/HTTP/TCP, RTP/RTSP/HTTPS/TCP, HTTP
Device Management Protocols	SNMP v2c, SNMP v3

PERIPHERALS	
USB Port	USB 2.0
Onboard Storage	Dual MicroSD/microSDHC/microSDXC slot - video speed class card required. Class V10 or better recommended. The dual SD cards will work as one contiguous region of storage.

AUXILIARY I/O	
Audio Compression Method	G.711 PCM 8 kHz, Opus
Audio Input/Output	Line level input and output
External I/O Terminal	Alarm In, Alarm Out

ELECTRICAL	IN-CEILING	SURFACE MOUNT	PENDANT MOUNT
Power Consumption	26 W with 24 VDC 37 VA with 24 VAC 25.5 W with IEE 802.3at Type 2 (PoE+)	With IR: 52 W with 24 VDC 74 VA with 24 VAC 51 W with high power PoE (PoE++) Without IR: 26 W with 24 VDC 37 VA with 24 VAC 25.5 W with IEEE 802.3at Type 2 (PoE+)	With IR: 52 W with 24 VDC 74 VA with 24 VAC 51 W with high power PoE (PoE++) Without IR: 26 W with 24 VDC 37 VA with 24 VAC 25.5 W with IEEE 802.3at Type 2 (PoE+)
External Power	24 VDC ± 10 %; 24 VAC rms ± 10 %, 50 or 60 Hz		
PoE*	30 W IEEE 802.3at Type 2 (PoE+)	With IR: 60 W (PoE++): IEEE 802.3bt Type 3, Cisco® UPoE or legacy high-power PoE* Up to 35% IR Power or without IR: 30 W IEEE 802.3at Type 2 (PoE+)	
Redundant Power	Seamless failover between PoE and Aux and back without interruption in camera operation		

* Supported high power PoE products are listed in the **Optional Injectors and Switches** Section and may require adjusting the PoE mode switch. Contact sales or technical support for more information.

MECHANICAL	IN-CEILING	SURFACE MOUNT	PENDANT MOUNT
Dimension	Overall: 298 mm x 161 mm (11.75" x 6.33") Below mounting surface: 298 mm x 64 mm (11.75" x 2.52")	304 mm x 114 mm (11.95" x 4.48")	With wall arm: 385 mm x 262 mm x 299 mm (15.15" x 10.30" x 11.77") With NPT adapter: 299 mm x 248 mm (11.77" x 9.76")
Weight	Mount: 1100 g (2.4 lbs)	Mount: 950 g (2.1 lbs)	Wall Mount: 1190 g (2.6 lbs)

MECHANICAL	IN-CEILING	SURFACE MOUNT	PENDANT MOUNT
	Bezel: 490 g (1.1 lbs) Camera Module (4 lenses): 1590 g (3.5 lbs)	Bezel: 1250 g (2.8 lbs) Camera Module (4 lenses): 1590 g (3.5 lbs) Optional IR Illuminator Ring: 670 g (1.5 lbs)	NPT Adapter Mount: 470 g (1.04 lbs) Pendant: 1680 g (3.7 lbs) Bezel: 1250 g (2.8 lbs) Camera Module (4 lenses): 1590 g (3.5 lbs) Optional IR Illuminator Ring: 670 g (1.5 lbs)
Body	Aluminum, Plastic dome trim	Aluminum	Aluminum
Finish	Plastic, Injection Molded, Pantone 427C	Cast, Anodized and Powder Coated, Pantone 427C	Cast, Anodized and Powder Coated, Pantone 427C
Optional IR Illuminator Ring	Not available	Optional accessory, 30 m (98 ft) IR range	

ENVIRONMENTAL	IN-CEILING	SURFACE MOUNT	PENDANT MOUNT
Operating Temperature	-10 °C to +50 °C (14 °F to 122 °F)	-40 °C to +60 °C (-40 °F to 140 °F)	
Storage Temperature	-30 °C to +70 °C (-22 °F to 158 °F)		
Humidity	0 - 95% non-condensing		
IR Illumination Behavior	Not available	<p>The IR illuminator will operate at 100% power from -40 °C to 44 °C (-40 °F to 111 °F). The IR power will reduce to 60% from 44 °C to 53 °C (111 °F to 127 °F). The IR illuminator will turn off when the temperature is greater than 53 °C (127 °F). Hysteresis: 6 °C (10.8 °F).</p> <p>For 25.5 W PoE+, the IR illuminator will operate at only 35% power and will turn off if the temperature is below -26 °C (-15 °F).</p>	

PER SENSOR	
Tilt	+7° to 96° from horizon
Pan	+/-120° (depending on position of image sensors)
Azimuth	+/-180°

CERTIFICATIONS	IN-CEILING	SURFACE MOUNT	PENDANT MOUNT
Certifications/Approvals	UL, cUL, CE, ROHS, RCM, UKCA		
Safety Standards	UL 62368-1, CSA 62368-1, IEC/EN 62368-1		
	UL 2043 (Plenum)	IEC/EN 62471	
Environmental Standards/Ratings	IEC 60529 IP5X rating (dust only)	IEC 60529 IP66, IP67 rating IEC/EN 62262 Impact (IK 10) IEC/EN 60068-2-6 Product Vibration IEC/EN 60068-2-27 Product Shock Type 4X	
Electromagnetic Emissions Standards	FCC Part 15 Subpart B (Class A) ICES-003 (Class A) EN 55032 (Class A) EN 61000-3-2 EN 61000-3-3		
Electromagnetic Immunity Standards	EN 55035 EN 61000-6-1 EN 50121-4 EN 50130-4		
NEMA TS2	Not applicable	NEMA TS2 paragraph 2.2.7 - 2.2.9	

SUPPORTED ANALYTICS EVENTS	
Objects in Area	The event is triggered when the selected object type moves into the region of interest.
Object Loitering	The event is triggered when the selected object type stays within the region of interest for an extended amount of time.
Objects Crossing Beam	The event is triggered when the specified number of objects have crossed the directional beam that is configured over the camera's field of view. The beam can be unidirectional or bidirectional.
Object Appears or Enters Area	The event is triggered by each object that enters the region of interest. This event can be used to count objects.

SUPPORTED ANALYTICS EVENTS

Object Not Present in Area	The event is triggered when no objects are present in the region of interest.
Objects Enter Area	The event is triggered when the specified number of objects have entered the region of interest.
Objects Leave Area	The event is triggered when the specified number of objects have left the region of interest.
Object Stops in Area	The event is triggered when an object in a region of interest stops moving for the specified threshold time.
Object Too Close	The event is triggered when an object moves to within a certain threshold distance of another object.
Direction Violated	The event is triggered when an object moves in the prohibited direction of travel.
Tamper Detection	The event is triggered when the scene unexpectedly changes.

SUPPORTED CLASSIFIED OBJECT TYPES

Object Types in Outdoor Mode	Person and Vehicle, sub-types: Car, Truck, Bicycle, Motorcycle, Bus
Object Types in Indoor Mode	Person

TEACH BY EXAMPLE

Object Types Teach By Example in Outdoor Mode	Yes, when used with Avigilon Control Center™.
---	---

OUTLINE DIMENSIONS

[X.X]	INCHES
X	MM

PENDANT WALL MOUNT

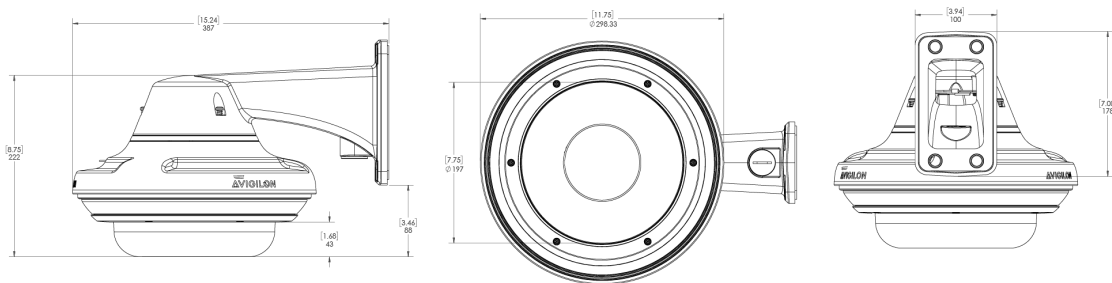

PENDANT NTP MOUNT

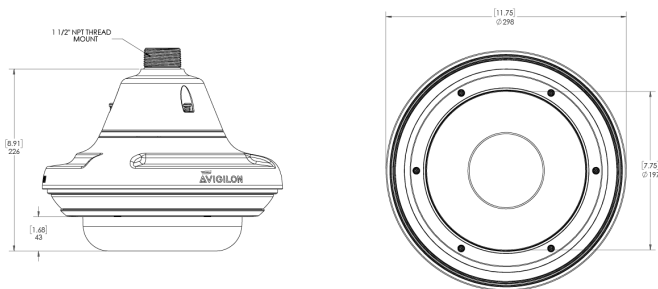

SURFACE MOUNT

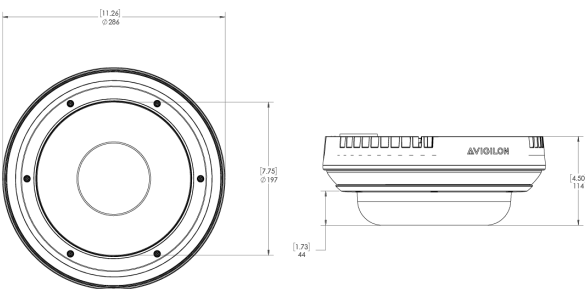

IN-CEILING MOUNT

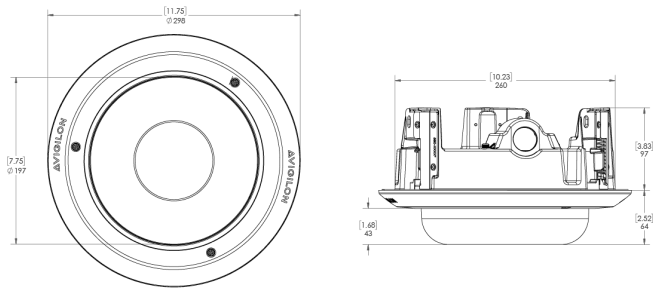

WALL MOUNT

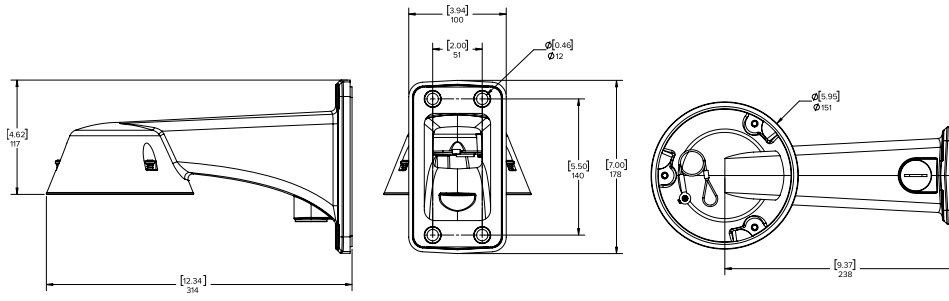

METAL CEILING PANEL

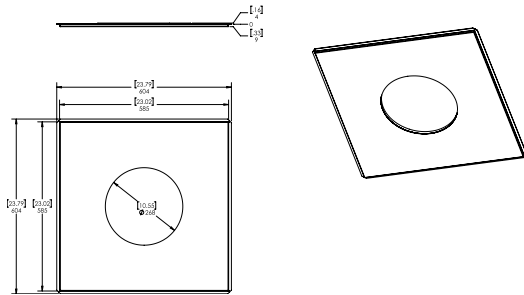

ORDERING INFORMATION

The variety of mounting options for the H5A Multisensor provides maximum flexibility. All the available camera modules can be used in any of the mounting options.

MOUNTING SCENARIO		ORDERING INFORMATION
PENDANT WALL MOUNT		Order one of: <ul style="list-style-type: none"> • Camera module • H5AMH-AD-PEND1 • H5AMH-DO-COVR1 or H5AMH-DO-COVR1-SMOKE • WLMT-1001 • Optional, H4AMH-AD-IRIL1
PENDANT NPT MOUNT		Order one of: <ul style="list-style-type: none"> • Camera module • H5AMH-AD-PEND1 • H5AMH-DO-COVR1 or H5AMH-DO-COVR1-SMOKE • NPTA-1001 • Optional, H4AMH-AD-IRIL1
SURFACE MOUNT		Order one of: <ul style="list-style-type: none"> • Camera module • H5AMH-AD-DOME1 • H5AMH-DO-COVR1 or H5AMH-DO-COVR1-SMOKE • Optional, H4AMH-AD-IRIL1
IN-CEILING MOUNT		Order one of: <ul style="list-style-type: none"> • Camera module • H4AMH-AD-CEIL1 • H5AMH-DC-COVR1 or H5AMH-DC-COVR1-SMOKE • Optional, CLPNL-1001 if ceiling panel is needed

CAMERA MODULES

With the modular design of the H5A Multisensor, any camera module can be paired with any mounting adapter for maximum versatility and optimal installation. Each camera module must be ordered with a matching mounting adapter and dome cover.

DISPLAY PART NUMBER	DESCRIPTION
9C-H5A-3MH	3X3MP, WDR, 270 degree max field of view, Lightcatcher, 3.3-5.7MM, Camera Only
12C-H5A-4MH	4X3MP, WDR, 360 degree max field of view, Lightcatcher, 3.3-5.7MM, Camera Only
15C-H5A-3MH	3X5MP, WDR, 270 degree max field of view, Lightcatcher, 3.3-5.7MM, Camera Only
20C-H5A-4MH	4X5MP, WDR, 360 degree max field of view, Lightcatcher, 3.3-5.7MM, Camera Only
24C-H5A-3MH	3X8MP, WDR, 270 degree max field of view, Lightcatcher, 3.3-5.7MM, Camera Only
32C-H5A-4MH	4X8MP, WDR, 360 degree max field of view, Lightcatcher, 3.3-5.7MM, Camera Only

MOUNTING ADAPTERS AND DOME COVERS

The H5A Multisensor modular design provides pendant, surface, or in-ceiling mounting adapters and a choice of two dome covers compatible with all the H5A Multisensor camera modules.

DISPLAY PART NUMBER	DESCRIPTION
H5AMH-AD-DOME1	Outdoor surface mount adapter, must order either a H5AMH-DO-COVR1 or H5AMH-DO-COVR1-SMOKE.
H5AMH-AD-PEND1	Outdoor pendant mount adapter, must order one of WLMT-1001 or NPTA-1001 and one of H5AMH-DO-COVR1 or H5AMH-DO-COVR1-SMOKE.
WLMT-1001	Pendant wall arm adapter, for use with H5AMH-AD-PEND1.
NPTA-1001	Pendant NPT adapter for use with H5AMH-AD-PEND1.
PLMT-1001	Aluminum pole mounting bracket, compatible with WLMT-1001.
CRNMT-1001	Aluminum corner mounting bracket, compatible with WLMT-1001.
H4AMH-AD-CEIL1	In-ceiling adapter, must order either a H5AMH-DC-COVR1 or H5AMH-DC-COVR1-SMOKE.
H5AMH-DO-COVR1	Dome bubble and cover, for outdoor surface mount or pendant mount, clear.
H5AMH-DO-COVR1-SMOKE	Dome bubble and cover, for outdoor surface mount or pendant mount, smoked. Not recommended for low light.
H5AMH-DC-COVR1	Dome bubble and cover, for in-ceiling mount, clear.
H5AMH-DC-COVR1-SMOKE	Dome bubble and cover, for in-ceiling mount, smoked. Not recommended for lowlight applications.
CPNL-1001	Metal ceiling panel.

OPTIONAL IR ILLUMINATOR

The optional IR Illuminator is available for the H5A Multisensor when mounted in a pendant or surface mount adapter.

DISPLAY PART NUMBER	DESCRIPTION
H4AMH-AD-IRIL1	Optional IR illuminator ring, for use with H5AMH-DO-COVR1.

OPTIONAL INJECTORS

DISPLAY PART NUMBER	DESCRIPTION
POE60U-1BTE	Gigabit 802.3bt 60 W PoE Injector, single port.
POE-INJ2-PLUS	Indoor single port POE+ injector. Injector operational temperature range -20 °C to +40 °C (-4 °F to 104 °F).

OPTIONAL ACCESSORIES

DISPLAY PART NUMBER	DESCRIPTION
USB-AC56-NA-MSI / USB-AC56-EU-MSI	USB Wi-Fi adapter.
CBLKT-1001	Cable kit replacement for Multi Head cameras.
CAM-FIPS	Camera license to enable FIPS cryptographic mode on the H5A Multisensor or any H5A camera.

SUPPORT

Learn more and find additional documentation at [avigilon.com](https://www.avigilon.com) or email sales@avigilon.com for specific product support.



Jan 2023 | Rev 1

© 2023, Motorola Solutions, Inc. All rights reserved. MOTOROLA, MOTO, MOTOROLA SOLUTIONS, and the Stylized M Logo are trademarks or registered trademarks of Motorola Trademark Holdings, LLC and are used under license. AVIGILON, the AVIGILON logo, AVIGILON CONTROL CENTER, ACC, HDSM SmartCodec and LIGHTCATCHER are trademarks of Avigilon Corporation. The absence of the symbols ™ and ® in proximity to each trademark in this document or at all is not a disclaimer of ownership of the related trademark. All other trademarks are the property of their respective owners.