

VAR2-IPPOE-w8-1 Medium Range White Light Network Illuminator



- Dedicated IP Lighting for Network Cameras
- Smart and Programmable
- Lighting that Responds to any Event
- Control Lights Individually or in Groups
- Integrated Web Interface
- Distances up to 180m (591ft)
- PLATINUM Elite SMT LED Technology
- Hot-spot Reduction Technology (HRT)
- VARIO Interchangeable Lens System
- Excellent Colour Rendition

VARIO2 IP illuminators provide dedicated lighting for IP cameras. They provide the ultimate solution for smart, situation-dependent lighting for video surveillance and can be fully integrated into an IP eco-system. VARIO2 IP enables users to create dynamic lighting systems, capable of controlling illuminators individually or in groups, to automatically deliver the exact amount of light where and when it is needed, improving image quality under any condition.

Set up is quick and easy, with Discovery software provided as standard. VARIO2 IP also reduces visits to site, minimising transport and labour costs and saving time, whilst ensuring maximum performance from your system at all times.

VARIO2 IP illuminators use PLATINUM Elite SMT LED technology to deliver more power and greater distances from a smaller platform than current generation illuminators.

The VARIO2 IP PoE w8-1 White-Light network illuminator delivers maximum distances up to 180m (591ft).

Product Dimensions

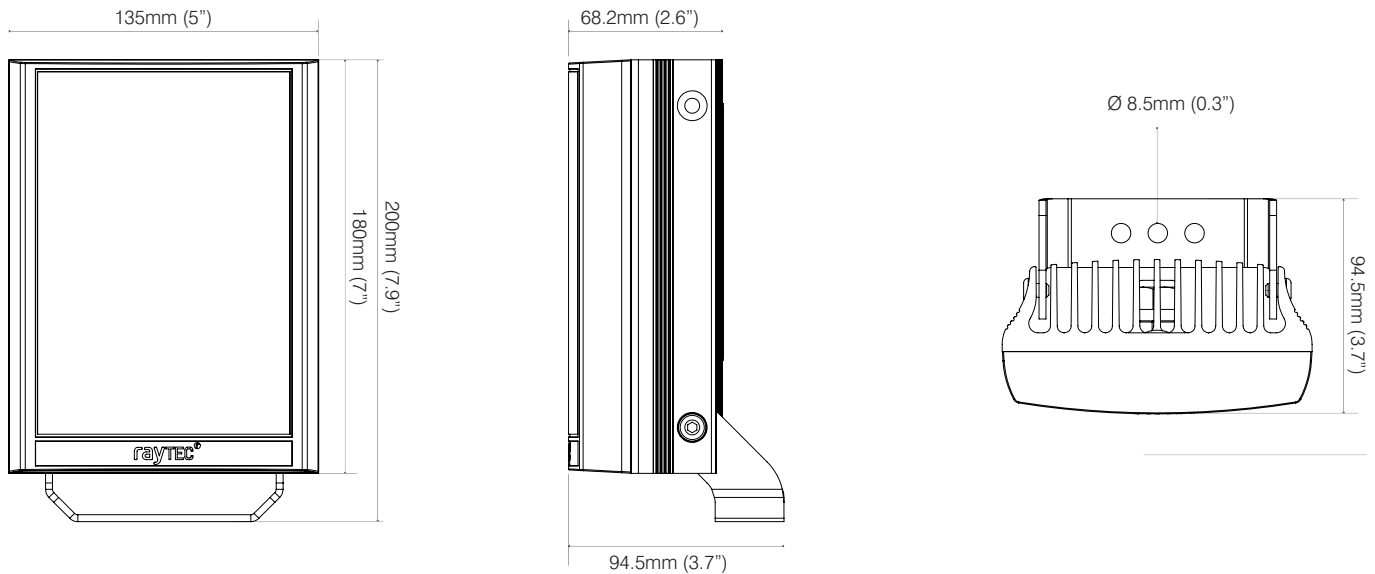

Features

Benefits

Dedicated IP Lighting with PoE

Remote control from anywhere on the network. Easy set-up, commissioning, operation and maintenance, minimising labour time and costs whilst maximising performance 24/7.

Integrated Web Interface

Provides quick access screen for instant response to live events in real time as well as a host of advanced programmable settings.

Advanced User Defined Settings

Integrated web interface provides a host of user defined additional settings and diagnostics tools. Tailor your solution to meet the exact demands of your installation.

API for Platform Integration

VARIO2 IP provides a dedicated API for seamless integration into 3rd party technology platforms such as VMS, BMS and Access Control Systems.

HTTP Commands as Standard

HTTP command functionality provides even more integration possibilities. HTTP commands can be used to control VARIO2 IP illuminators from any network enabled device.

Platinum Elite SMT LED Technology

VARIO2 illuminators use cutting-edge PLATINUM Elite SMT LED technology together with an enhanced Cool Running™ thermal management system to deliver World leading power, reliability and flexibility.

VARIO Interchangeable Lens System

Angle of illumination can be easily, quickly and precisely adjusted by changing the VARIO holographic lens insert, to match the specific camera field of view.

Hot-spot Reduction Technology (HRT)

Hot-spot Reduction Technology (HRT) delivers a highly diffused, elliptical beam shape to deliver more light where it is needed, generating both longer distances and minimizing light wastage. The HRT system also prevents overexposure of foreground objects.

5 YEAR WARRANTY

All Raytec luminaires are provided with an industry leading 5 year warranty and have an expected useful life in excess of 10 years



Technical Specifications

Illuminator

Total Lumens	3727lm per luminaire
Max Distance	180m (591ft)
Angle	Standard pack includes 10° circular + 35° x 10° (fitted as standard) and 60° x 25° elliptical lenses. Additional optional lenses: 80° x 30°, 120° x 50°
Input	60W PoE++ (4-pair PoE)* or 24V DC
Consumption	47W
Data Input	Cat 5 Cable
Beam Shape	Elliptical with HRT (Hot-spot Reduction Technology)
Beam Angle System	VARIO Interchangeable Lens System
LED type	Platinum Elite SMT LEDs
Number of LEDs	24
Wavelength	White-Light
Colour Temp	6000K~
Colour Reproduction Index	>70
IP rating	IP66
Temperature Range	-50° to +50°C (-58 to 122°F)
Colour	Silver
Weight	1.65kg (3.6lbs)
Dimensions	135 x 180 x 68.2mm (5" x 7" x 3.2" approx)
Cable Length	2 x 2.5m
Bracketry	U bracket included VUB Bracketry also available(Optional)
Minimum System Requirements	PC running Windows 7 with IE8 and network access.
Country of Manufacture	United Kingdom

*Compatible with MicroSemi/ PowerDSine and Phihong PSE devices, excluding Cisco. Contact Raytec for further information.

Integrated Command and Control Technology

Hardware Features	<ul style="list-style-type: none"> In-built photocell for automatic on/off operation Photocell following output External telemetry input
Quick Access Software Features (provided as standard via integrated web interface)	<ul style="list-style-type: none"> Individual or group control (Groups up to 16 units) Power On/Off Power control: 20-100% Boost: 120% power for 10 seconds Deterrent feature with selectable patterns and speeds
Advanced User Defined Software Features: (provided as standard via integrated web interface)	<ul style="list-style-type: none"> Timer functions Soft start turn on 3 x deterrent patterns 3 x deterrent speeds Selectable external telemetry input: volt – free or TTL Photocell sensitivity trigger level Assign illuminator to group for collective control Administrator and user access levels Password Protection: create user and administrator passwords Assign name, group name and IP address Restore factory defaults Restart/reboot Software upgrade Standard and advanced diagnostics Supported protocols include HTTP, Local and VMS operating modes (including combinations) Ping command functionality
System Integration (Application Programming Interface)	<ul style="list-style-type: none"> API for integration into 3rd party platforms API for integration into network devices via HTTP commands

POWERS – The Open Lighting Standard

Specifications and distances based on the POWERS lighting standard
For full POWERS data and A&E specifications please contact sales@rayteccctv.com

Product Codes

Part Codes	Description	Angles	Distances
VAR2-IPPOE-w8-1	VARIO2 IP PoE w8 Network Illuminator, 3 angle options included, 24V DC or PoE++ power input, silver, White-Light	10 x 10 °	180m (591ft)
		35 x 10°(fitted as standard)	95m (312ft)
		60 x 25°	50m (164ft)
		80 x 30° (optional)	35m (115ft)
		120 x 50° (optional)	25m (82ft)

Optional Parts

VAR-w8-LENS-8030	Individual w8 VARIO lens – 80°H x 30°V
VAR-w8-LENS-12050	Individual w8 VARIO lens – 120°H x 50°V