

SENTECH

USB3 Vision 2.3 MP CMOS Product Specifications



Features

- USB3 Vision Compatibility
- 2.3 MP CMOS Sensors
- 163 FPS
- Available with Multiple ROI

Safety Precautions

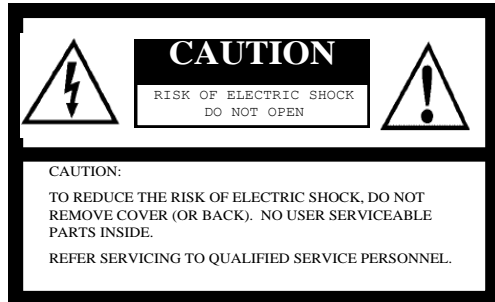

For U.S.A.

Warning:

This equipment generates and uses radio frequency energy and if not installed and used properly, i.e., in strict accordance with the instruction manual, may cause harmful interference to radio communications. It has been tested and found to comply with the limits for a Class A computing device pursuant to Subpart J of Part 15 of FCC Rules, which are designed to provide reasonable protection against such interference when operated in a commercial environment.

For Canada

Warning:

This digital apparatus does not exceed the Class A limits for radio noise emissions from digital apparatus set out in the Radio Interference Regulations of the Canadian Department of Communications.



The lightning flash with arrowhead symbol, within an equilateral triangle, is intended to alert the user to the presence of uninsulated "dangerous voltage" within the product's enclosure that may be of sufficient magnitude to constitute a risk of electric shock to persons.



The exclamation point within an equilateral triangle is intended to alert the user to the presence of important operating and maintenance (servicing) instructions in the literature accompanying the appliance.

WARNING:

TO PREVENT FIRE OR SHOCK HAZARD, DO NOT EXPOSE THIS APPLIANCE TO RAIN OR MOISTURE.

Product Precautions

- Handle the camera with care. Do not abuse the camera. Avoid striking or shaking it. Improper handling or storage could damage the camera.
- Do not pull or damage the camera cable.
- During camera use, do not wrap the unit in any material. This will cause the internal temperature of the unit to increase.
- Do not expose the camera to moisture, or do not try to operate it in wet areas.
- Do not operate the camera beyond its temperature, humidity and power source ratings.
- While the camera is not being used, keep the lens or lens cap on the camera to prevent dust or contamination from getting in the sensor or filter area and scratching or damaging this area.
- Do not keep the camera under the following conditions:
 - In wet, moist, and high humidity areas
 - Under hot direct sunlight
 - In high temperature areas
 - Near an object that releases a strong magnetic or electric field
 - Areas with strong vibrations
- Apply the power that satisfies the requirements specified in this document to the camera.
- Use a soft cloth to clean the camera. Use pressured air spray to clean the surface of the glass. DO not scratch the surface of the glass.

- The camera is a general-purpose electronic device; using the camera for the equipment that may threaten human life or cause dangers to human bodies directly in case of failure or malfunction of the camera is not guaranteed. Use the camera for special purposes at your own risk.
- Defect pixels may appear due to the sensor characteristics.
- During camera use, do not plug or unplug other USB devices (USB storage, etc.). Plugging or unplugging other devices may result in a failure to recognize the USB camera.
- Increasing gain level may increase the noise level.
- When the camera is in Long Exposure mode, the noise level may increase.

Contents

1	OVERVIEW	5
1.1	FEATURES	5
1.2	ITEM NUMBERS NAMING METHOD	5
2	SPECIFICATIONS	6
2.1	ELECTRONIC SPECIFICATIONS	6
2.2	SPECTRAL SENSITIVITY CHARACTERISTICS	8
2.2.1	<i>STC-MBS241U3V</i>	8
2.2.2	<i>STC-MCS241U3V</i>	8
2.3	FILTER SPECIFICATION (STC-MCS241U3V)	9
2.4	MECHANICAL SPECIFICATIONS	10
2.5	ENVIRONMENTAL SPECIFICATIONS	10
2.6	POWER/IO CONNECTOR.....	11
2.6.1	<i>Pin Assignment</i>	11
2.6.2	<i>Input Output DC Characteristics</i>	11
2.6.3	<i>Default Setting of Input Output</i>	12
2.6.4	<i>GPIO Circuit (Input)</i>	12
2.6.5	<i>GPIO Circuit (Output)</i>	13
2.1	DETAIL OF CAMERA FUNCTION.....	16
2.1.1	<i>ROI</i>	16
3	DIMENSIONS	18
4	REVISION HISTORY	19

1 Overview

This document describes the specification of the following cameras:

STC-MBS241U3V / MCS241U3V

1.1 Features

- USB3 Vision
- Frame Rate (Full Scan) :163fps@2.3MP
- CMOS Global Shutter
- Up to 64 Pixel Defect Correction (Default: ON)
- 8bit,10bit, 12bit output

1.2 Item Numbers Naming Method

Each character of the camera item number has the following designations:

STC-MxS241U3V

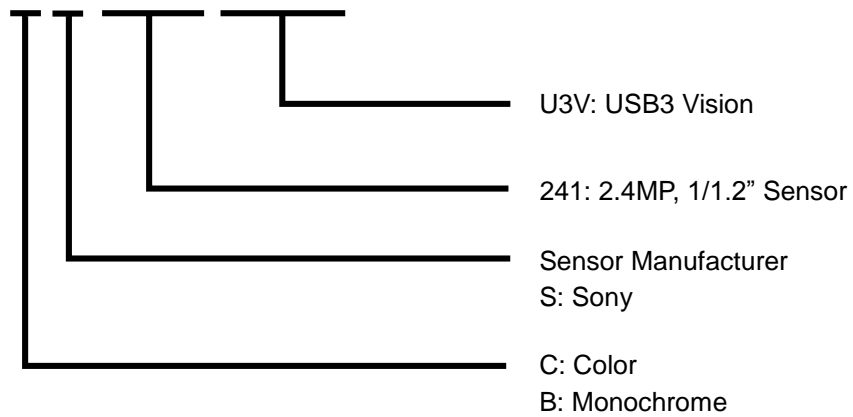

2 Specifications

2.1 Electronic Specifications

Model Number		STC-MCS241U3V	STC-MBS241U3V
Image Sensor		1/1.2" 2.35 MP Color CMOS (SONY: IMX174)	1/1.2" 2.35 MP Monochrome CMOS (SONY: IMX174)
Active Picture Elements		1920 (H) x 1200 (V)	
Cell Size		5.86 (H) x 5.86 (V) μ m	
Scanning System		Progressive	
Shutter Type		Global Shutter	
Scanning Mode		Full Scanning, Variable ROI (Horizontal and Vertical)	
Maximum Frame Rate (in Full Scanning Mode)		1920 x 1200: 163 fps (RAW8bit), 81.5 fps (RAW10bit) , 81.5 fps (RAW12bit) *Frame rate will drop if connected to the USB 2.0 port	
Maximum Frame Rate (in AOI Mode)		1280 x 1024: 189 fps (RAW8bit), 94 fps (RAW10bit/Raw12bit) 640 x 480: 378 fps (RAW8bit), 189 fps (RAW10bit/Raw12bit)	
Sync. System		Internal	
Video Output Format		RAW8bit / 10bit / 12bit (Default: RAW8bit)	RAW8bit / 10bit / 12bit (Default: RAW8bit)
S/N Ratio (8bit)		< 3 digit (Gain 0 dB)	
Electronic Shutter		Exposure Time: 18.6 usec to 20 sec (in full scanning mode, RAW8bit) Exposure Time: 23.4 usec to 40 sec (in full scanning mode, RAW10bit/RAW12bit)	
Gain	Analog	0 to 24 dB	
	Digital	0 to 6 dB	
Offset	Analog	RAW8bit: 0 to 31 digit, RAW12bit: 0 to 511 digit	
ROI *1		ROI (Horizontal: 32 to 1920 pixels / Vertical: 32 to 1200 lines) (Default: 1920 x 1200) Adjustable Steps for offset: 2 pixels in horizontal direction and 2 lines in vertical direction Adjustable Steps for image size: 16 pixels in horizontal direction and 4 lines in vertical direction Adjustable Steps for ROI 16 Regions, 16 pixels in horizontal direction and 4 lines in vertical direction	
Binning Function *2		N/A	Individual x2 Horizontal, Vertical Binning (Frame rate does not increase)
Decimation Function *3		Individual x2 Horizontal, Vertical Decimation (Frame rate increases with the vertical decimation, but the frame rate does not increase with the horizontal decimation)	Individual x2 Horizontal, Vertical Decimation (Frame rate increases with the vertical decimation, but the frame rate does not increase with the horizontal decimation)
ALC		AE, AGC (Default AE:OFF, AGC:OFF)	
White Balance		Auto, Manual, One Push (Default: Manual)	N/A
Mirror Image		Horizontal / Vertical / Horizontal and Vertical (Default: OFF)	
Pixel Defect Correction		Up to 64 pixels (Default: ON)	
Operational Mode *4		Free-run / Edge-preset Trigger / Pulse width trigger / Start/Stop trigger*6	
User Setting Storage		Support	
Interface		USB3.0 Super speed (USB3.0 Micro B)	
Input / Output		Three GPIO, One Camera Hardware Reset	
Power *6	Input Voltage	+5V (typ.) (This conforms to the USB standard)	
	Consumption	< 4 W	

Table 1: Electronic Specifications (STC-MCS241U3V/STC-MBS241U3V)

Precautions

- *1 Please refer to section [3.1.1 ROI](#) for further details on the ROI.
- *2 Binning & Decimation cannot work simultaneously.
- *3 The Binning & Decimation units do not change.
- *4 The user should not input the trigger more frequently than the maximum frame rate.
If the trigger was input during the sensor ReadOut timing, ReadOut will be interrupted. This trigger will cause the exposure to end.
- *5 Start/Stop trigger mode is only available for the software trigger.
- *6 When using this camera with USB2.0 port, please considering the power consumption because this camera operates as USB3.0 standard.

How to obtain full frame rate

This general guideline may help the user obtain the full frame rate (2.3M:163fps) from the camera.

To obtain the full frame rate (2.3M:163fps), the data transfer speed on the USB bus depends on the capability of the host controller.

Renesas / Fresco Logic's host controller improved the data transfer speed drastically in the second generation. Intel's chipset increased the transfer speed 10% to 20%.

When PCIExpress board of USB3.0 interface is used, please insert the PCIExpress Gen2.0(5.0[GT/s]) slot. If non-PCIExpress Gen2.0(5.0[GT/s]) is used, data transfer speed could decrease by about 50%.

If an incapable host controller causes a lower frame rate, the camera frame rate should be set lower than the maximum to adjust for the incapable host controller spec. This may resolve the issue.

Due to the huge data transfer, PC resources may be consumed during the process. If this occurs, the frame rate of the camera may be effected.

2.2 Spectral Sensitivity Characteristics

2.2.1 STC-MBS241U3V

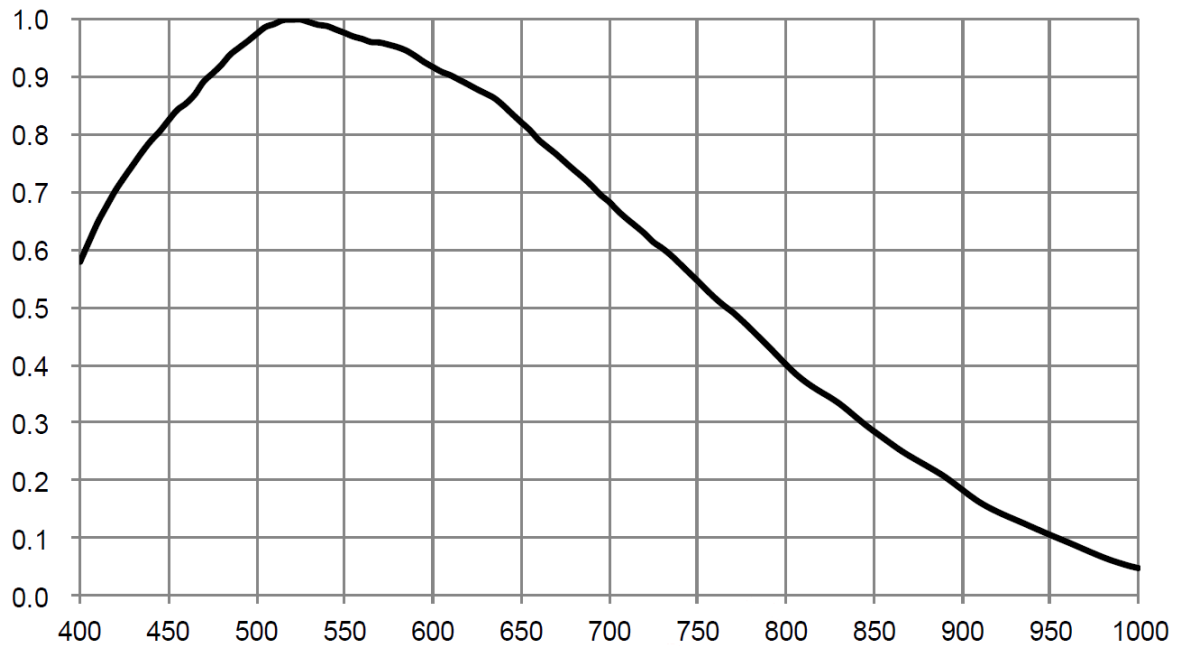

2.2.2 STC-MCS241U3V

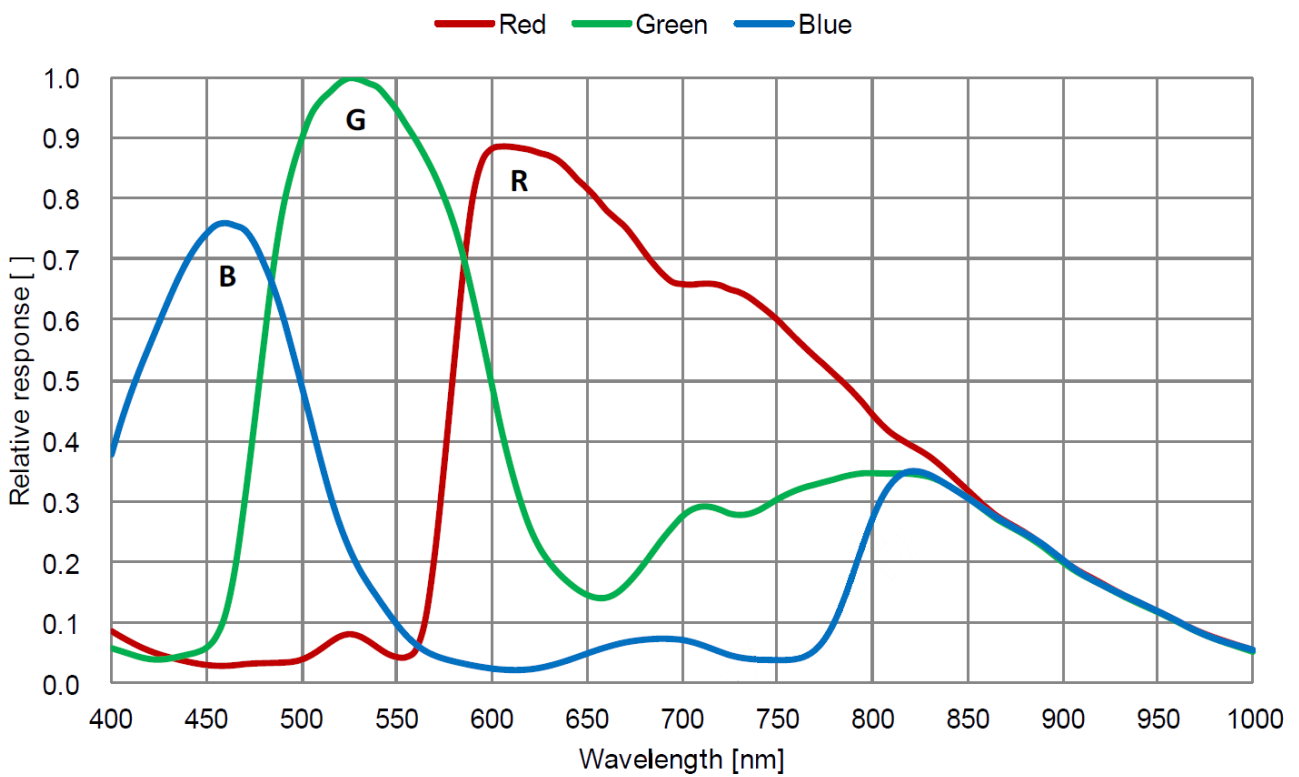

2.3 Filter Specification (STC-MCS241U3V)

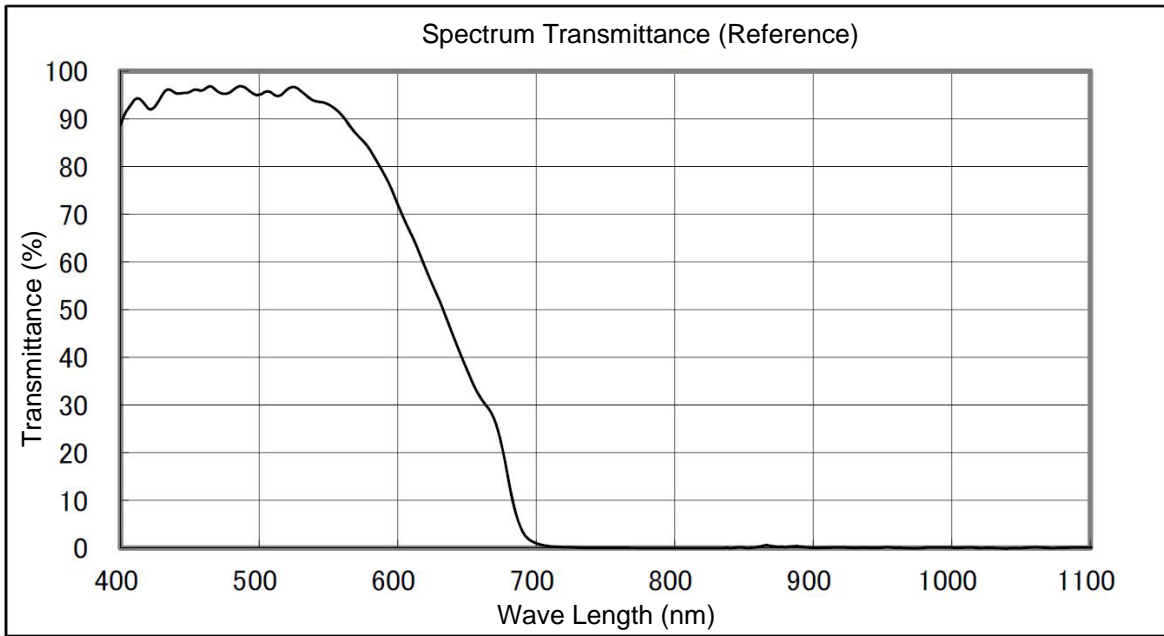

2.4 Mechanical Specifications

Model Number	STC-MCS241U3V	STC-MBS241U3V
Dimensions	C Mount: 28 (W) x 28 (H) x 40 (D) mm *excluding the connectors	
Lens Mount	C Mount	
Optical Filter	IR Cut Filter	No IR Cut Filter
Optical Center Accuracy	Positional accuracy in Horizontal and Vertical directions: +/- 0.3 mm Rotational accuracy of Horizontal and Vertical: +/- 1.5 deg.	
Weight	Approx. 48 g	
Interface Connectors	USB Connector: USB3.0 Micro B type I/O Connector: HR10A-7R-6PB (Hirose) or equivalent	

Table 3: Mechanical Specifications

2.5 Environmental Specifications

Model Number	STC-MCS241U3V/MBS241U3V	
Operational Temperature	Minimum	Environmental Temperature: 0 °C
	Maximum	Camera housing temperature (top plate) shall not exceed 56 °C *1
Storage Temperature	Environmental Temperature: -30 to +65 °C, Environmental Humidity: 0 to 85%	
Vibration	20Hz to 200Hz to 20Hz (5min./cycle), acceleration 10G, XYZ 3 directions 30 min. each	
Shock	Acceleration 38G, half amplitude 6ms, XYZ 3 directions 3 times each	
Standard Compliance	EMS: EN61000-6-2, EMI: EN55011	
RoHS	RoHS Compliant	

Table 4: Environmental Specifications

*1: Please insure that the camera is installed with the appropriate heat dissipation. If the camera has a mounted lens and a tripod with an aluminum plate, this could decrease the camera housing temperature for heat dissipation. When the internal temperature sensor on the camera shows less than 64 °C, the camera housing temperature (top plate) will be less than 56 °C.

Upper side of camera

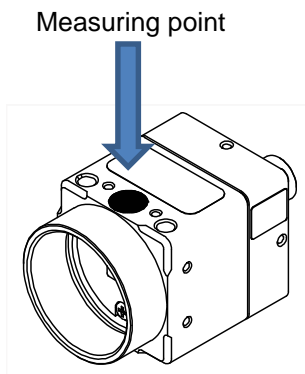

2.6 Power/IO Connector

HR10A-7R-6PB (Hirose) or equivalent.

This connector is for the input and output signals.

The trigger input and sync input /output signals can be assigned through the camera setting communication.

As for the cable part (Female connector), HR10A-7P-6S (Hirose) or equivalent can be used.

2.6.1 Pin Assignment

Pin No.	Signal Name	IN/OUT
1	GPIO_GND	-
2	GPIO2	IN/OUT
3	GPIO1	IN/OUT
4	GPIO0	IN/OUT
5	CAM_RESET	IN
6	N.C.	-

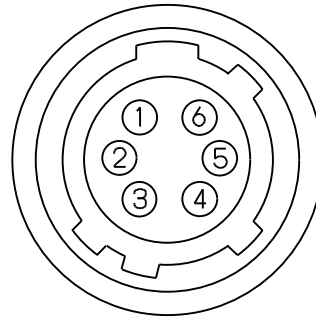

*Possible Maximum Rated Voltage is +24V on CAM_RESET, GPIO0, GPIO1 and GPIO2.

*Please set to "OPEN" on NC (Pin 6).

2.6.2 Input Output DC Characteristics

Pin No.	Signal Name	Function	IN/OUT	Voltage		Current	Reference	
				Low Voltage	High Voltage			
1	IO_GND	GND	-			-	-	
2	GPIO2	General Purpose Input Output	IN/OUT	IN	Less than+1.00V	+3.00 to +24V	4uA(typ.)	2
				OUT	0 to +2.20V(*1)	+3.00 to +24V(*2)	15mA (Max.)(*3)	3,4
3	GPIO1	General Purpose Input Output	IN/OUT	IN	Less than+1.00V	+3.00 to +24V	4uA(typ.)	2
				OUT	0 to +2.20V(*1)	+3.00 to +24V(*2)	15mA (Max.)(*3)	3,4
4	GPIO0	General Purpose Input Output	IN/OUT	IN	Less than+1.00V	+3.00 to +24V	4uA(typ.)	2
				OUT	0 to +2.20V(*1)	+3.00 to +24V(*2)	15mA (Max.)(*3)	3,4
5	CAM_RESET	Camera Hardware Reset	IN	IN	Less than +0.80V	+3.00 to +24V	4uA(typ.)	1
6	N.C.	NC	-			-	-	

*1: If the current on the IO port is at 15mA when using low voltage output, the output voltage could increase for the internal register.

*2: This is the maximum charging voltage when the external IO port is connected. Equivalent VCCext on Reference 4.

*3: When the external IO port is connected, control the current less than 15mA on the IO port.

*4: This is the typical current value that occurs when High Voltage is input into the Input port.

2.6.3 Default Setting of Input Output

Pin No.	Signal Name	Default	
		IN/OUT	Setting
2	GPIO2	IN	Disable
3	GPIO1	IN	Disable
4	GPIO0	IN	Disable

2.6.4 GPIO Circuit (Input)

Input Signal Functions

No.	Function	Polarity
1)	Disable (Default)	-
2)	General Input	-
3)	Trigger Input	Positive or Negative

- 1) Disable
This function should be set when no input signal is necessary.
- 2) General Input
This function can set high or low level and the user can use this to check the status on the software.
- 3) Trigger Input
This function is used for the trigger signal in the edge preset mode.

CAM_RESET(Reference 1)

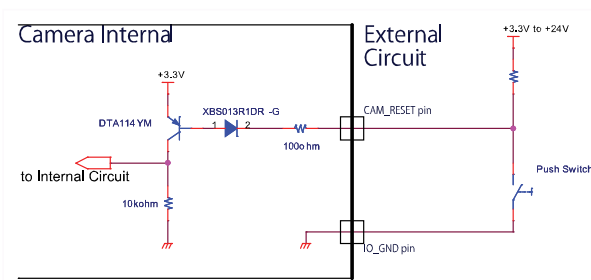

Camera can be reset after connecting the GND in 5 seconds on this circuit.
Note: It is necessary to set Hardware Reset to ON, as the Default setting is OFF.

General Purpose Input (Reference 2)

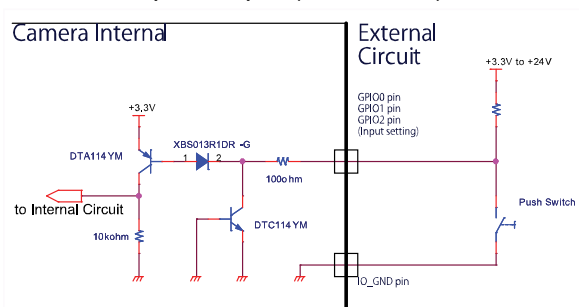

Input Response Characteristics

Response characteristics of CAM_RESET (Reference1), General Purpose Input (Reference 2) are shown in the following diagrams:

Td	0.07 usec
Tr	0.06 usec
Ts	4.87 usec
Tf	1.67 usec

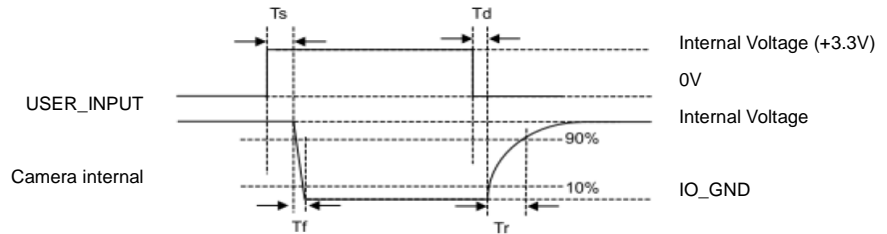

Capable input trigger's pulse width is
 Positive Edge: more than $T_s + T_f$
 Negative Edge: more than $T_d + T_r$

2.6.5 GPIO Circuit (Output)

Output Signal Functions

No/	Function	Polarity
1)	Disable (Default)	-
2)	General Output	-
3)	Trigger Output (Programmable)	Positive or Negative
4)	Trigger Output (Loop Through)	Positive or Negative
5)	Exposure End	Positive or Negative
6)	CCD Read End Output	Positive or Negative
7)	Strobe Output (Programmable)	Positive or Negative
8)	Strobe Output (Exposure)	Positive or Negative
9)	Trigger Valid Out	Positive or Negative
10)	Transfer End	Positive or Negative

- 1) Disable
This function should be set when no output signal is necessary.
- 2) General Output
This function outputs high or low level signals set on the software.
- 3) Trigger Output (Programmable)
This function outputs the trigger input signal with pulse delay setting and pulse duration applied.
- 4) Trigger Output (Loop Through)
This function outputs the trigger input signal (with a slight internal delay).
- 5) Exposure End
This function outputs with pulse delay setting and pulse duration applied when exposure is completed.

- 6) CCD Read End Output
This function outputs with pulse delay setting and pulse duration applied when one frame transfer from sensor completed.
- 7) Strobe Output (Programmable)
This function outputs with strobe delay setting and strobe duration applied when trigger input signal received.
- 8) Strobe Output (Exposure)
*Actual exposure duration = Output Pulse Width + Minimum Exposure Time 22 usec
- 9) Trigger Valid Out
When used with the positive polarity setting, high status indicates that the input trigger signal is acceptable. This signal becomes low from the exposure start to the end of image output.
When used with the negative polarity setting, low status indicates that the input trigger signal is acceptable. This signal becomes high from the exposure start to the end of image output.
- 10) Transfer End
This function outputs with pulse delay setting and pulse duration applied when one frame transfer from camera completed.

General Purpose Output (Reference 3)

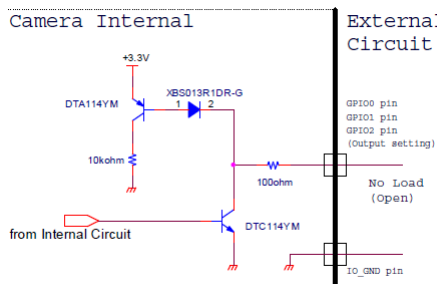

General Purpose Output (Reference 4)

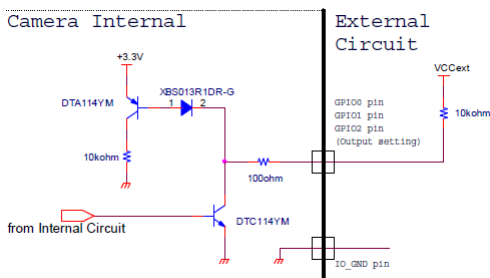

Characteristics of the output signals

Response characteristics of the General Purpose output (Reference 3), and General Purpose output (Reference 4) are shown in the diagram below. Pulse width is configurable through the software.

Please refer to the following response timing table.

	VCCext			
	OPEN(*1)	5V (*2)	12V (*2)	24V (*2)
Td	1.82 usec	1.72 usec	1.77 usec	1.72 usec
Tr	8.58 usec	0.97 usec	0.91 usec	0.89 usec
Ts	0.11 usec	0.12 usec	0.14 usec	0.15 usec
Tf	0.10 usec	0.13 usec	0.23 usec	0.36 usec

*1: Reference 3. Measured on +1.8V internal Voltage.

*2: Reference 4

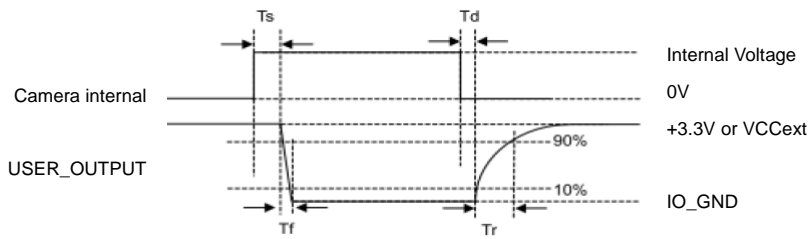

2.1 Detail of Camera Function

2.1.1 ROI

When using the ROI function, please follow the instructions below:

The image data format on MultiROI is Sentech's original format, this data does not follow USB3 Vision format. Therefore, the MultiROI function will not work on any 3rd party's USB3 Vision compliant application.

If the user wants to use the MultiROI function, one of the following applications are required.

- An application based on Sentech's SDK(Standard/Trigger)
 - An application based on Sentech's DirectShowFilter
 - An application based on Sentech's GenTL module(※)
- ※ It is necessary for the user to implement the process for Sentech's original format in the user's application.

MultiROI can set 16 regions as Region0~15.

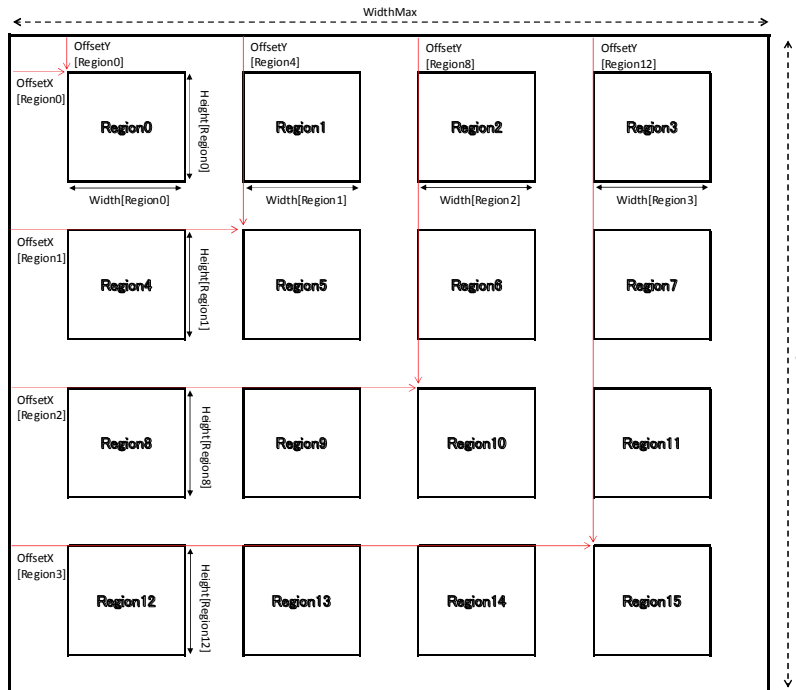

Restricted items for ROI function:

Region0 is always active.

It is necessary to activate the first horizontal region and the first vertical region to activate another region. (For examples, when activating "Region10", it is necessary to activate "Region2" and "Region8".

when activating "Region14", it is necessary to activate "Region3" and "Region12".)

For the width setting:

The width of Region0 is applied to Region4, 8 and 12 too.

The width of Region1 is applied to Region5, 9 and 13 too.

The width of Region2 is applied to Region6, 10 and 14 too.

The width of Region3 is applied to Region7, 11 and 15 too.

For the height setting:

- The height of Region0 is applied to Region1, 2 and 3 too.
- The height of Region4 is applied to Region5, 6 and 7 too.
- The height of Region8 is applied to Region9, 10 and 11 too.
- The height of Region12 is applied to Region13, 14 and 15 too.

For the offsetX setting:

- The offsetX of Region0 is applied to Region4, 8 and 12 too.
- The offsetX of Region1 is applied to Region5, 9 and 13 too.
- The offsetX of Region2 is applied to Region6, 10 and 14 too.
- The offsetX of Region3 is applied to Region7, 11 and 15 too.

For the offsetY setting:

- The offsetY of Region0 is applied to Region1, 2 and 3 too.
- The offsetY of Region4 is applied to Region5, 6 and 7 too.
- The offsetY of Region8 is applied to Region9, 10 and 11 too.
- The offsetY of Region12 is applied to Region13, 14 and 15 too.

Overlapping images for each region is prohibited.

Region number 0 to 15 should be assigned rotated image when Horizontal / Vertical / Horizontal and Vertical setting is used on the camera.

This camera outputs all of active regions' images as one image data.

The width and the height corresponds to the obtained image's size.
When Binning/Decimation is enabled, Binning/Decimation size should be equal.

Region position and settings for the horizontal and the vertical mirror image.

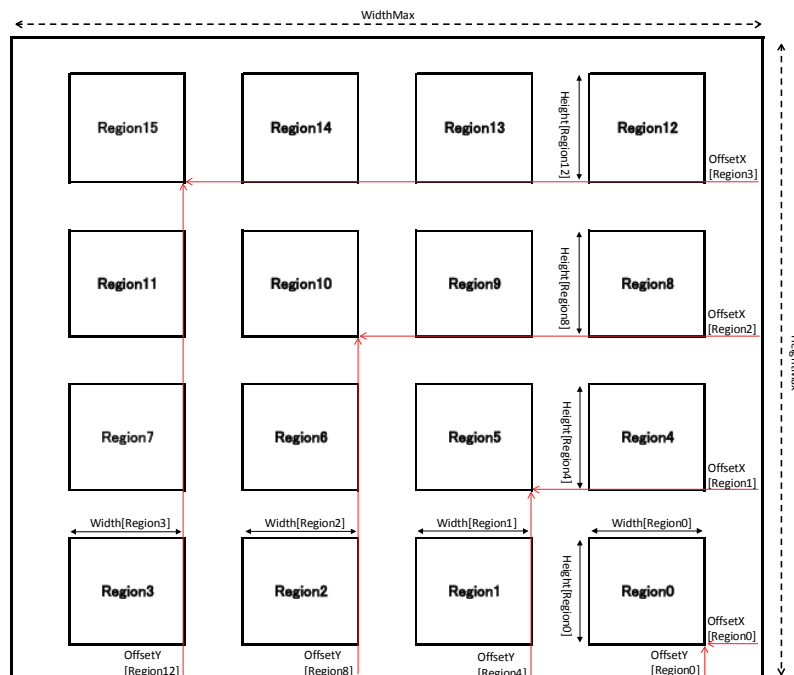

3 Dimensions

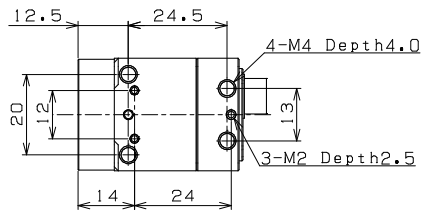
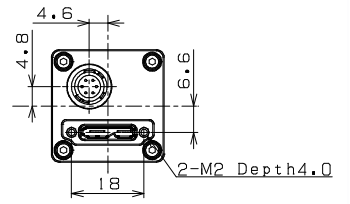
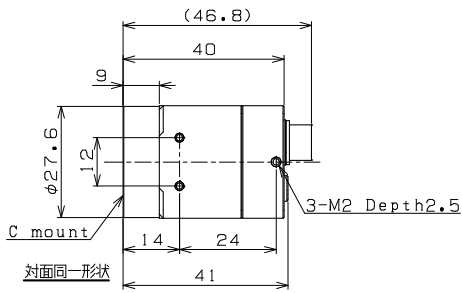
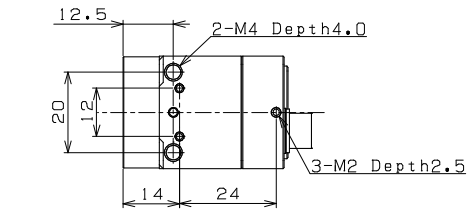
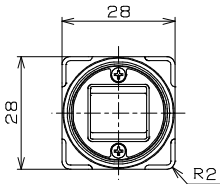
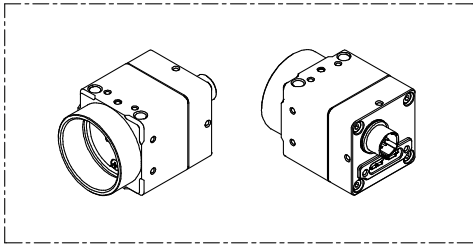

Unit: mm

4 Revision History

Rev	Date	Changes	Note
00	2015/02/23	<ul style="list-style-type: none">● New document	
01	February 23, 2015	<ul style="list-style-type: none">● Completed English Translation of the Documents● Updated	