

**SENTECH**

## **CMOS Camera Link Series**

**Small Cubic Type, 2MP / 4MP CMOS  
Color / Monochrome Camera Link Camera**

## Safety Precautions

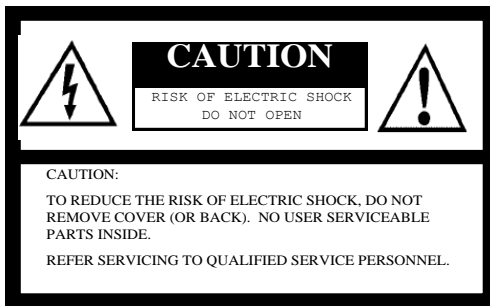

For U.S.A.

**Warning:**

This equipment generates and uses radio frequency energy and if not installed and used properly, I.e., in strict accordance with the instruction manual, may cause harmful interference to radio communications. It has been tested and found to comply with the limits for a Class A computing device pursuant to Subpart J of Part 15 of FCC Rules, which are designed to provide reasonable protection against such interference when operated in a commercial environment.

For Canada

**Warning:**

This digital apparatus does not exceed the Class A limits for radio noise emissions from digital apparatus set out in the Radio Interference Regulations of the Canadian Department of Communications.



The lightning flash with arrowhead symbol, within an equilateral triangle, is intended to alert the user to the presence of uninsulated “dangerous voltage” within the product’s enclosure that may be of sufficient magnitude to constitute a risk of electric shock to persons.



The exclamation point within an equilateral triangle is intended to alert the user to the presence of important operating and maintenance (servicing) instructions in the literature accompanying the appliance.

**WARNING:**

**TO PREVENT FIRE OR SHOCK HAZARD, DO NOT EXPOSE THIS APPLIANCE TO RAIN OR MOISTURE.**

## Product Precautions

- Handle the camera with care. Do not abuse the camera. Avoid striking or shaking it. Improper handling or storage could damage the camera.
- Do not pull or damage the camera cable.
- During camera use, do not wrap the unit in any material. This will cause the internal temperature of the unit to increase.
- Do not expose the camera to moisture, or do not try to operate it in wet areas.
- Do not operate the camera beyond its temperature, humidity and power source ratings.
- While the camera is not being used, keep the lens or lens cap on the camera to prevent dust or contamination from getting in the CCD or filter area and scratching or damaging this area.
- Do not keep the camera under the following conditions:
  - In wet, moist, and high humidity areas
  - Under hot direct sunlight
  - In high temperature areas
  - Near an object that releases a strong magnetic or electric field
  - Areas with strong vibrations
- Use a soft cloth to clean the camera. Use pressured air spray to clean the surface of the glass. DO not scratch the surface of the glass.

## Copyright & Disclaimer

Sensor Technologies America, Inc. (DBA Sentech America) believes the contents and specifications of its website, catalog, documentation and ads are correct; however, Sentech America provides no representation or warranty regarding such information or product(s) contained therein. It is requested that Sentech America be given appropriate acknowledgement in any subsequent use of such work by a third party.

While every effort has been made to ensure that the details contained in Sentech America's website and all documentation are correct and up-to-date, Sentech America assumes no liability, legal or otherwise for any errors in listings, specifications, part numbers, process, software or model applications. Sentech America reserves the right to change specifications, product descriptions, product quality, pricing and application at any time without prior written or oral notice. Any party using such information assumes all risk for any and all damaged caused to themselves, a third party and/or property by virtue of incorrect information and/or failure of these products. By installing and/or using a Sentech America software development kit or other similar product and/or information obtained from Sentech America's website, catalog, documentation or ads, you hereby accept and understand these stated terms and conditions.

## Contents

<b>I. Introduction</b> .....	<b>8</b>
A. Features.....	8
B. Naming Specification .....	8
<b>II. Specifications</b> .....	<b>9-18</b>
A. Electronic / Mechanical / Environmental Specifications.....	9-10
1. STC-CMB2MCL / STC-CMC2MCL .....	9
2. STC-CMB4MCL / STC-CMC4MCL .....	10
B. Spectral Sensitivity Characteristics .....	11-12
1. STC-CMB2MCL / STC-CMB4MCL .....	11
2. STC-CMC2MCL / STC-CMC4MCL .....	11
3. STC-CMC2MCL-NIR / STC-CMC4MCL-NIR (Near IR Model) .....	12
C. Connector Specifications .....	13-16
1. Camera Link Connectors .....	13
2. Power / IO Connector .....	14-16
D. Dimensions.....	17
E. Accuracy of Sensor Position .....	18
<b>III. Camera Installation</b> .....	<b>19</b>
<b>IV. Camera Output Timing Charts</b> .....	<b>20-58</b>
A. Horizontal Timing (STC-CMB2MCL / CMC2MCL / STC-CMB4MCL / CMC4MCL) .....	20-36
1. 2 TAPS (1X2-1Y) / Horizontal 2,048 Pixels.....	20
2. 4 TAPS (1X4-1Y) / Horizontal 2,048 Pixels.....	21
3. 8 TAPS (1X8-1Y) / Horizontal 2,048 Pixels.....	22-23
4. 10 TAPS (1X10-1Y) / Horizontal 2,040 Pixels.....	24-25
5. 2 TAPS (1X2-1Y) / Horizontal 1,024 Pixels.....	26
6. 2 TAPS (1X2-1Y) / Horizontal 512 Pixels.....	27
7. 4 TAPS / Horizontal 1,024 Pixels .....	28
8. 2 TAPS (1X2-1Y) / 2 x 2 Binning.....	29
9. 4 TAPS (1X4-1Y) / 2 x 2 Binning.....	30

10. 2 TAPS (1X2-1Y) / 4 x 4 Binning.....	31
11. 1 TAPS (1X-1Y) / 8 x 8 Binning.....	32
12. 2 TAPS (1X2-1Y) / 2 x 2 Subsampling.....	33
13. 4 TAPS (1X4-1Y) / 2 x 2 Subsampling.....	34
14. 2 TAPS (1X2-1Y) / 4 x 4 Subsampling.....	35
15. 1 TAPS (1X-1Y) / 8 x 8 Subsampling.....	36
<b>B. Vertical Timing.....</b>	<b>37-47</b>
1. Full Scan (STC-CMB2MCL / CMC2MCL).....	39
2. Full Scan (STC-CMB4MCL / CMC4MCL).....	40
3. 2 x 2 Binning (STC-CMB2MCL / CMC2MCL).....	41
4. 4 x 4 Binning (STC-CMB2MCL / CMC2MCL).....	41
5. 8 x 8 Binning (STC-CMB2MCL / CMC2MCL).....	41
6. 2 x 2 Subsampling (STC-CMB2MCL / CMC2MCL).....	43
7. 4 x 4 Subsampling (STC-CMB2MCL / CMC2MCL).....	43
8. 8 x 8 Subsampling (STC-CMB2MCL / CMC2MCL).....	43
9. 2 x 2 Binning (STC-CMB4MCL / CMC4MCL).....	45
10. 4 x 4 Binning (STC-CMB4MCL / CMC4MCL).....	45
11. 8 x 8 Binning (STC-CMB4MCL / CMC4MCL).....	45
12. 2 x 2 Subsampling (STC-CMB4MCL / CMC4MCL).....	47
13. 4 x 4 Subsampling (STC-CMB4MCL / CMC4MCL).....	47
14. 8 x 8 Subsampling (STC-CMB4MCL / CMC4MCL).....	47
<b>C. AOI Timing.....</b>	<b>49-51</b>
<b>D. Camera Link Bit Assignment.....</b>	<b>52-55</b>
<b>E. Camera Link Tap Geometry.....</b>	<b>56-57</b>
1. 2 Tap (1X2-1Y).....	56
2. 4 Tap (1X4-1Y).....	56
3. 8 Tap (1X8-1Y).....	57
4. 10 Tap (1X10-1Y).....	57
<b>F. Bayer Pattern for Color Models.....</b>	<b>58</b>
<b>V. Camera Function Modes.....</b>	<b>59-63</b>
<b>A. Normal Mode.....</b>	<b>59</b>
1. Normal Mode (Electronic Shutter).....	59

- B. Pulse Width Trigger Mode ..... 60-61
  - 1. Pulse Width Trigger Mode (V-Reset)..... 60
  - 2. Pulse Width Trigger Mode (Exposure Timing)..... 61
- C. Edge Preset Trigger Mode..... 62-63
  - 1. Edge Preset Trigger Mode (V-Reset) ..... 62
  - 2. Edge Preset Trigger Mode (Exposure Timing) ..... 63
- VI. The Communication Protocol Specifications ..... 64-78**
  - A. The Communication Method ..... 64
  - B. The Communication Settings ..... 64
  - C. The Communication Format ..... 64-65
  - D. The Camera Control Commands..... 66-78
    - 1. The Camera Commands List ..... 66-67
    - 2. Descriptions of the Camera Control Commands..... 68-77
    - 3. The Sequence for Saving Commands to the EEPROM..... 78
- VII. Control Software..... 79-86**
  - A. Summary ..... 79-81
    - 1. File ..... 80
    - 2. Comm ..... 80
    - 3. Mode ..... 81
    - 4. Help ..... 81
  - B. Software Function (Standard) ..... 81-84
    - 1. Shutter ..... 81
    - 2. Mode ..... 82
    - 3. Gain ..... 83
    - 4. Serial Communication..... 83
    - 5. Flip ..... 83
    - 6. Other ..... 84
  - C. Software Function (Partial) ..... 85
  - D. Software Function (Advanced) ..... 85
  - E. Software Function (HDR)..... 85
  - F. Software Function (SP\_Pin)..... 86
- VIII. Actual Camera Settings & Technical Notes ..... 87-89**

A. Using the Trigger Signal Through the 6pin ..... 87

B. Example setting of AOI..... 88-89

## I. Introduction

This document describes the specifications and users guide of cameras described below.

STC-CMB2MCL / STC-CMB2MCL-NIR	(2M Monochrome / Near IR)
STC-CMC2MCL	(2M Color)
STC-CMB4MCL / STC-CMB4MCL-NIR	(4M Monochrome / Near IR)
STC-CMC4MCL	(4M Color)

## A. Features

- CMOS Sensor
- Camera Link (Full, Medium, Base Configuration)
- 10,8,4,2 TAP
- 2 x 2, 4 x 4, 8 x 8 Binning and 2 x 2, 4 x 4, 8 x 8 Subsampling
- PoCL
- Support Near IR Sensor

## B. Naming Specification

### STC-CMxxMCL-x

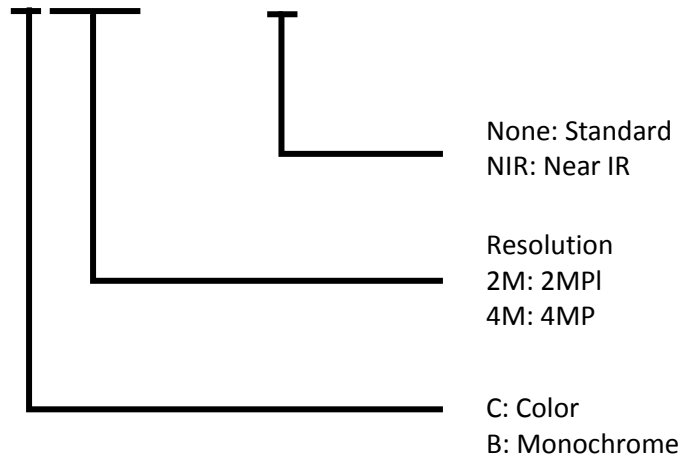



## II. Specifications

### A. Electronic Specifications / Mechanical Specifications / Environmental Specifications

#### 1. STC-CMB2MCL (2MP, Monochrome) / STC-CMB2MCL-NIR (2MP, Near IR) / STC-CMC2MCL (2MP, Color)

Product		STC-CMC2MCL		STC-CMB2MCL		
Electronic specifications	Imager	2/3" Meg color progressive CMOS (CMOSIS: CMV2000)		2/3" Meg monochrome progressive CMOS (CMOSIS: CMV2000)		
	Active picture elements	2048 (H) x 1088 (V)				
	Chip size	11.264x5.984 mm				
	Cell size	5.5 (H) x 5.5 (V) μm				
	Scanning system	Progressive				
	Scanning method	Full scanning, Variable AOI		Full scanning, Variable AOI Binning scanning, Binning variable AOI		
	Pixel frequency of the sensor	1X2-1Y	(8bit/10bit):	10.625MHz (2,048 x 1,088), 21.250MHz (1,024 x 1,088), 42.500MHz (512 x 1,088)		
		1X4-1Y	(8bit/10bit):	21.250MHz (2,048 x 1,088), 42.500MHz (1,024 x 1,088)		
		1X8-1Y	(8bit):	42.500MHz (2,048 x 1,088)		
		1X10-1Y	(8bit):	48.000MHz (2,040 x 1,088)		
	Frame rate Vertical frequency of the Camera Link output	1X2-1Y	(8bit/10bit):	73.8fps (2,048 x 1,088), 147.6fps (1,024 x 1,088), 295.2fps (512 x 1,088)		
		1X4-1Y	(8bit/10bit):	147.6fps (2,048 x 1,088), 295.2fps (1,024 x 1,088)		
		1X8-1Y	(8bit):	295.2fps (2,048 x 1,088)		
		1X10-1Y	(8bit):	333.4fps (2,040 x 1,088)		
	Horizontal frequency of the Camera Link output	1X2-1Y	(8bit/10bit):	82kHz (2,048 x 1,088), 164kHz (1,024 x 1,088), 329kHz (512 x 1,088)		
		1X4-1Y	(8bit/10bit):	164kHz (2,048 x 1,088), 329kHz (1,024 x 1,088)		
		1X8-1Y	(8bit):	329kHz (2,048 x 1,088)		
		1X10-1Y	(8bit):	372kHz (2,040 x 1,088)		
	Pixel frequency of the Camera Link output	1X2-1Y	(8bit/10bit):	85MHz/42.5MHz		
		1X4-1Y	(8bit/10bit):	85MHz/42.5MHz		
1X8-1Y		(8bit):	85MHz/42.5MHz			
1X10-1Y		(8bit):	80MHz/40MHz			
Noise level (8bit output)	Less than 3 Digit (Gain 0 dB)					
Dynamic range	60 dB					
Minimum scene illumination *Near IR model (-NIR)	6 Lux at F1.2		2 Lux at F1.2			
	-		TBD Lux at F1.2			
Sync. System	Internal					
Video output	@8bit output	10TAP / FULL / MIDEUM / BASE configuration				
	@10bit output	MIDEUM / BASE configuration				
Shutter speed	45 seconds to 25.8u seconds (Variable at line)					
Digital gain	1x to 4x					
Gamma	1.0					
Power	Input voltage	12Vdc ± 10% (PoCL or Power/IO connector)				
	Consumption	Less than 4.5 W				
Operation mode	Free-run, Edge preset trigger (V-reset), Pulse width trigger (V-reset)					
Communication	RS232 via Camera Link connector					
Mechanical specifications	Dimensions	50 (W) x 50 (H) x 40.5 (D) mm (Excluding the connector)				
	Optical filter	No IR cut filter				
	Material	Aluminum (AC)				
	Lens mount	C mount				
	Interface connector	Camera Link connector: SDR connector x 2 Power/IO connector: HR10A-7R-6PB (Hirose) or equivalent				
	Weight	Approximately 140 g				
	Environmental specifications	Operational temperature	-5 to 40 deg. C			
Storage temperature		-30 to 65 deg. C				
Vibration		20Hz to 200Hz to 20Hz (5min./cycle), acceleration 10G, XYZ 3 directions 30 min. each				
Shock		Acceleration 38G, half amplitude 6ms, XYZ 3 directions 3times each				
Standard compliancy		EMS: EN61000-6-2, EMI: EN55022 (Class B)				
RoHS		RoHS compliance				

2. STC-CMB4MCL (4MP, Monochrome) / STC-CMB4MCL-NIR (4MP, Near IR) / STC-CMC4MCL (4MP, Color)

Product		STC-CMC4MCL			STC-CMB4MCL		
Electronics specifications	Imager	1" 4Meg color progressive CMOS (CMOSIS: CMV4000)			1" 4Meg monochrome progressive CMOS (CMOSIS: CMV4000)		
	Active picture elements	2048 (H) x 2048 (V)					
	Chip size	11.264x11.264 mm					
	Cell size	5.5 (H) x 5.5 (V) $\mu$ m					
	Scanning system	Progressive					
	Scanning method	Full scanning, Variable AOI			Full scanning, Variable AOI Binning scanning, Binning variable AOI		
	Pixel frequency of the sensor	1X2-1Y	(8bit/10bit):	10.625MHz (2,048 x 2,048), 21.250MHz (1,024 x 2,048), 42.500MHz (512 x 2,048)			
		1X4-1Y	(8bit/10bit):	21.250MHz (2,048 x 2,048), 42.500MHz (1,024 x 2,048)			
		1X8-1Y	(8bit):	42.500MHz (2,048 x 2,048)			
		1X10-1Y	(8bit):	48.000MHz (2,040 x 2,048)			
	Frame rate Vertical frequency of the Camera Link output	1X2-1Y	(8bit/10bit):	39.7fps (2,048 x 2,048), 79.3fps (1,024 x 2,048), 158.7fps (512 x 2,048)			
		1X4-1Y	(8bit/10bit):	79.3fps (2,048 x 2,048), 158.7fps (1,024 x 2,048)			
		1X8-1Y	(8bit):	158.7fps (2,048 x 2,048)			
		1X10-1Y	(8bit):	179.2fps (2,040 x 2,048)			
	Horizontal frequency of the Camera Link output	1X2-1Y	(8bit/10bit):	82kHz (2,048 x 2,048), 164kHz (2,024 x 1,048), 329kHz (512 x 2,048)			
		1X4-1Y	(8bit/10bit):	164kHz (2,048 x 2,048), 329kHz (1,024 x 2,048)			
		1X8-1Y	(8bit):	329kHz (2,048 x 2,048)			
		1X10-1Y	(8bit):	372kHz (2,040 x 2,048)			
	Pixel frequency of the Camera Link output	1X2-1Y	(8bit/10bit):	85MHz/42.5MHz			
		1X4-1Y	(8bit/10bit):	85MHz/42.5MHz			
1X8-1Y		(8bit):	85MHz/42.5MHz				
1X10-1Y		(8bit):	80MHz/40MHz				
Noise level (8bit output)		Less than 3 Digit (Gain 0 dB)					
Dynamic range		60 dB					
Minimum scene illumination *Near IR	6 Lux at F1.2			2 Lux at F1.2			
	-			TBD Lux at F1.2			
Sync. System		Internal					
Video output	@8bit output	10TAP / FULL / MIDEUM / BASE configuration					
	@10bit output	MIDEUM / BASE configuration					
Shutter speed		45 seconds to 25.8 $\mu$ s (Variable at line)					
Digital gain		1x to 4x					
Gamma		1.0					
Power	Input voltage	12Vdc $\pm$ 10% (PoCL or Power/IO connector)					
	Consumption	Less than 4.5 W					
Operation mode		Free-run, Edge preset trigger (V-reset), Pulse width trigger (V-reset)					
Communication		RS232 via Camera Link connector					
Mechanical specifications	Dimensions	50 (W) x 50 (H) x 40.5 (D) mm (Excluding the connector)					
	Optical filter	No IR cut filter					
	Material	Aluminum (AC)					
	Lens mount	C mount					
	Interface connector	Camera Link connector: SDR connector x 2 Power/IO connector: HR10A-7R-6PB (Hirose) or equivalent					
	Weight	Approximately 140 g					
Environmental specifications	Operational temperature	-5 to 40 deg. C					
	Storage temperature	-30 to 65 deg. C					
	Vibration	20Hz to 200Hz to 20Hz (5min./cycle), acceleration 10G, XYZ 3 directions 30 min. each					
	Shock	Acceleration 38G, half amplitude 6ms, XYZ 3 directions 3times each					
	Standard compliancy	EMS: EN61000-6-2, EMI: EN55022 (Class B)					

	RoHS	RoHS compliance
--	------	-----------------

## B. Spectral Sensitivity Characteristics

### 1. STC-CMB2MCL / STC-CMB4MCL

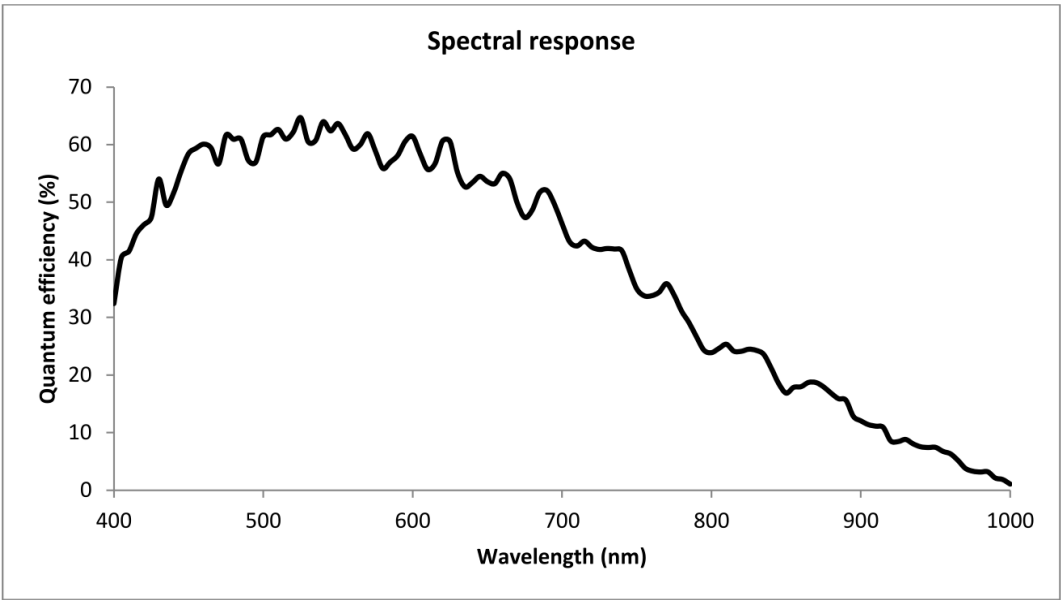

### 2. STC-CMC2MCL / STC-CMC4MCL

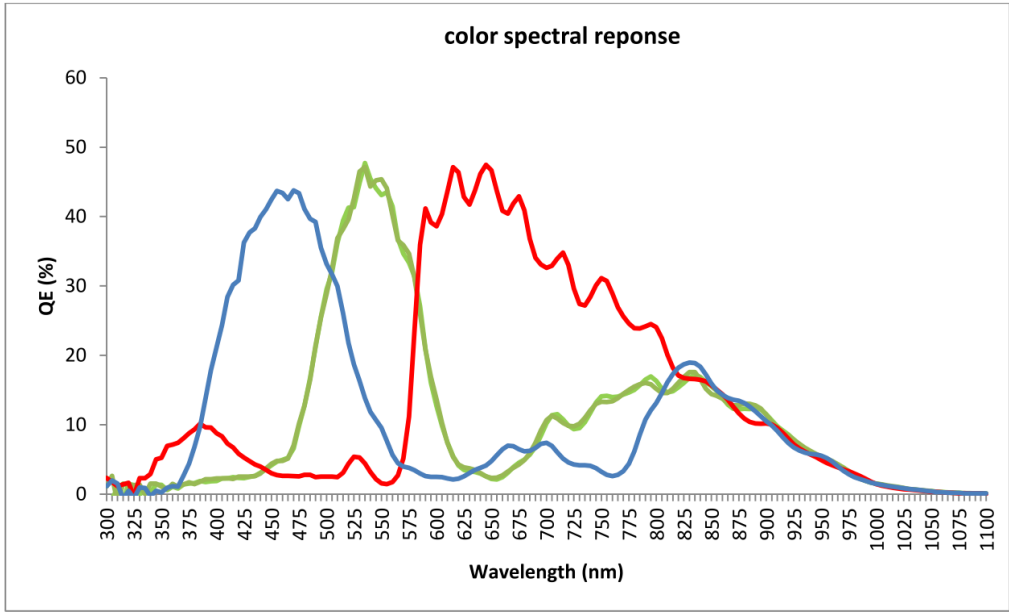

### 3. STC-CMB2MCL-NIR / STC-CMB4MCL-NIR (Near IR Model)

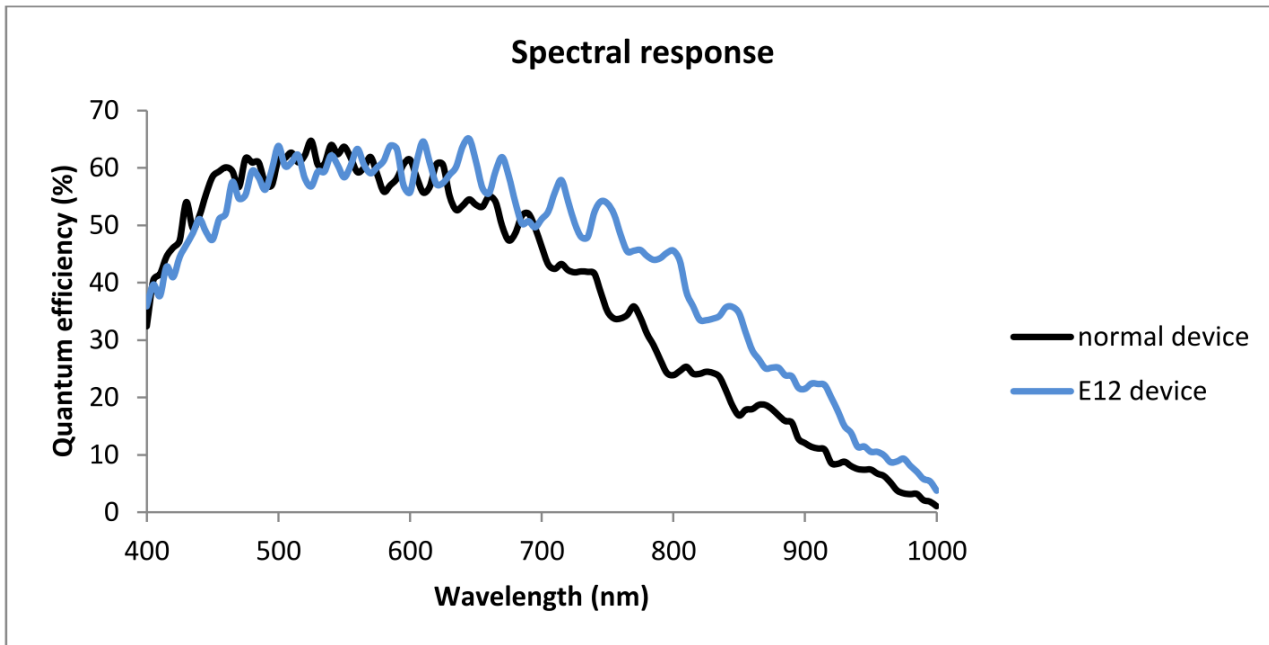

## C. Connector Specifications

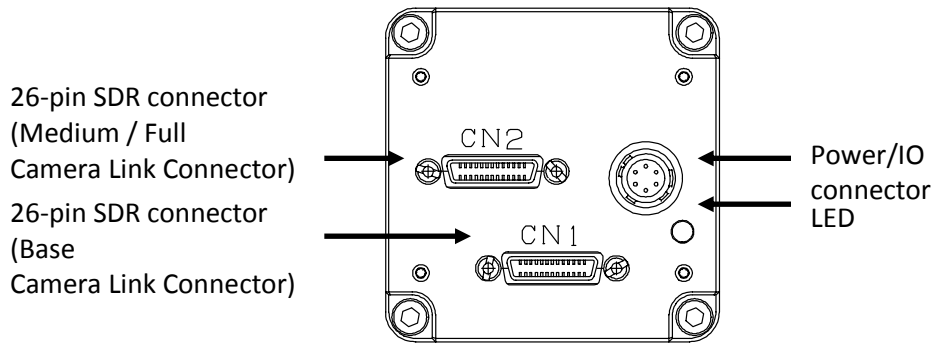

26-pin SDR connector  
(Medium / Full  
Camera Link Connector)

26-pin SDR connector  
(Base  
Camera Link Connector)

Power/IO  
connector  
LED

### 1. Camera Link Connectors: SDR (3M) Equivalent x 2

**(Caution)**

This product is a PoCL type.

When the frame grabber board and the cable are compatible with PoCL the frame grabber board supplies power to the camera. In this case, please DO NOT supply the power from the Power/IO connector.

When the frame grabber board and the cable are NOT compatible with PoCL, please input the power from the Power/IO connector.

#### a. Pin Assignment

Base Camera Link Connector

Pin No.	Signal name	Pin No.	Signal name
1	+12V	14	GND
2	X0-	15	X0+
3	X1-	16	X1+
4	X2-	17	X2+
5	Xclk-	18	Xclk+
6	X3-	19	X3+
7	SerTC+	20	SerTC-
8	SerTFG-	21	SerTFG+
9	CC1- (TRG)	22	CC1+ (TRG)
10	CC2+	23	CC2-
11	CC3-	24	CC3+
12	CC4+	25	CC4-
13	GND	26	+12V

Medium / Full Camera Link Connector

Pin No.	Signal name	Pin No.	Signal name
1	+12V	14	GND
2	Y0-	15	Y0+
3	Y1-	16	Y1+
4	Y2-	17	Y2+
5	Yclk-	18	Yclk+
6	Y3-	19	Y3+
7	100 Ohm	20	100 Ohm
8	Z0-	21	Z0+
9	Z1-	22	Z1+
10	Z2-	23	Z2+
11	Zclk-	24	Zclk+
12	Z3-	25	Z3+
13	GND	26	+12V

## 2. Power / IO Connector

HR10A-7R-6PB (Hirose) or equivalent.

This connector is for 12Vdc power input and the input and output signals.

The trigger input and sync input / output signals can be assigned through the camera setting communication.

### a. Pin Assignment

Pin No	Signal Name	N/OUT	Voltage		
				Low Voltage	High Voltage
1	GND	N	0V		
2	SP-4	N/OUT	N	0 ~ +0.99V	+2.3 ~ +5.0V
			OUT	0V	+3.3V
3	SP-3	N/OUT	N	0 ~ +0.99V	+2.3 ~ +5.0V
			OUT	0V	+3.3V
4	SP-2	N/OUT	N	0 ~ +0.99V	+2.3 ~ +5.0V
			OUT	0V	+3.3V
5	SP-1	N/OUT	N	0 ~ +0.99V	+2.3 ~ +5.0V
			OUT	0V	+3.3V
6	+12V dc	N	+12V dc		

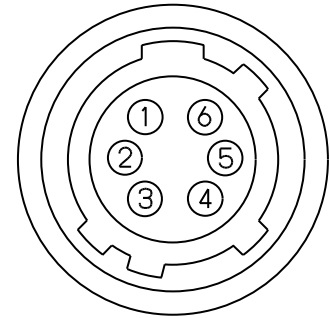

(Note 1)

Trigger input signal can be assigned either on Camera Link connector (CC1) or on the No. 2 pin of the power/IO connector through the camera setting communication.

As for the actual setting of the hardware trigger, please refer to Section: VIII-A: Using the Trigger Signal through 6pin

b. Input Signal Circuit

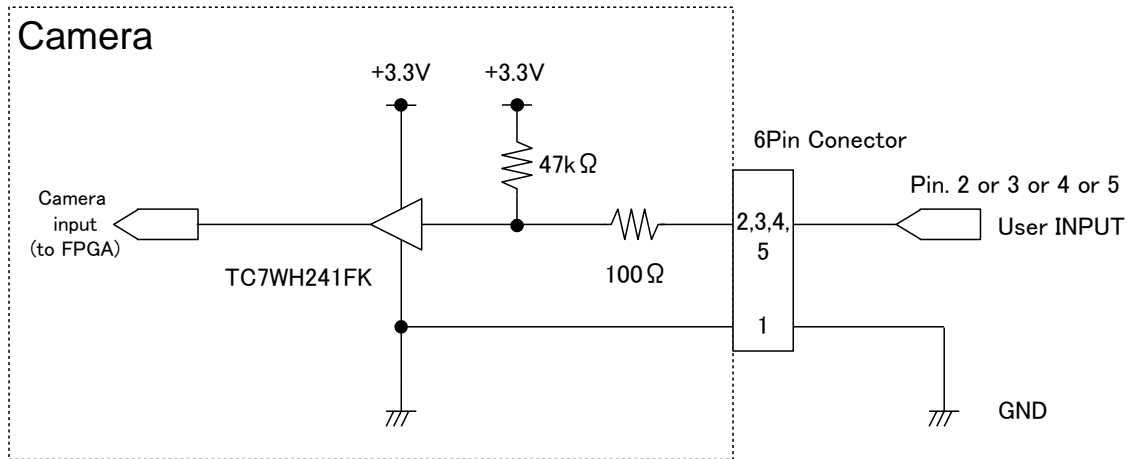

c. Input Signal Circuit Examples

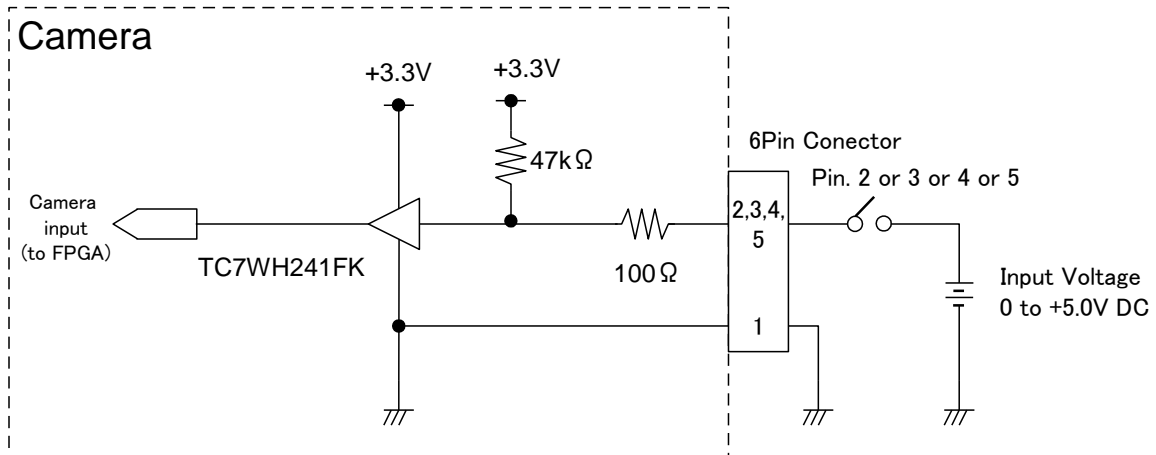

d. Output Signal Circuit / Examples

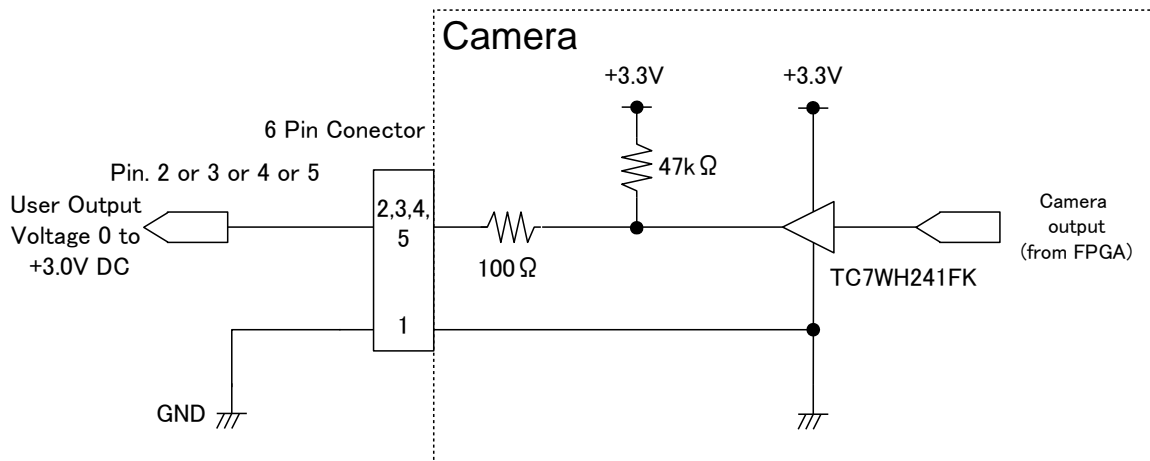



e. LED Information

Mode setting	LED
D9H.0 = 1	OFF
Trigger mode	On 1 second then Off 1 second (repeatedly)
Free run	ON

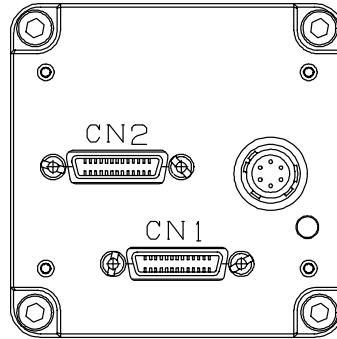

## D. Dimensions

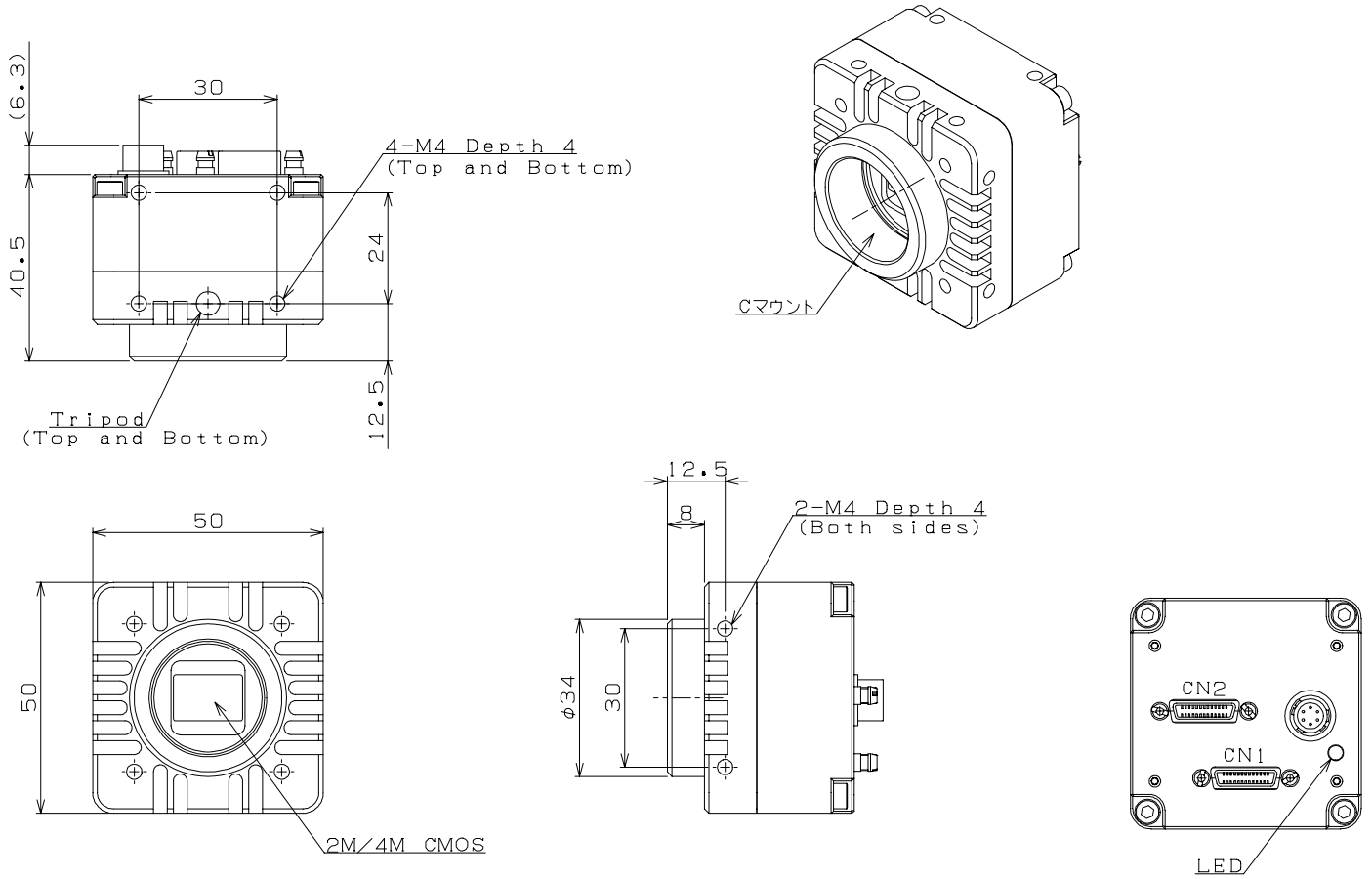

Unit: mm

## E. Accuracy of Sensor Position

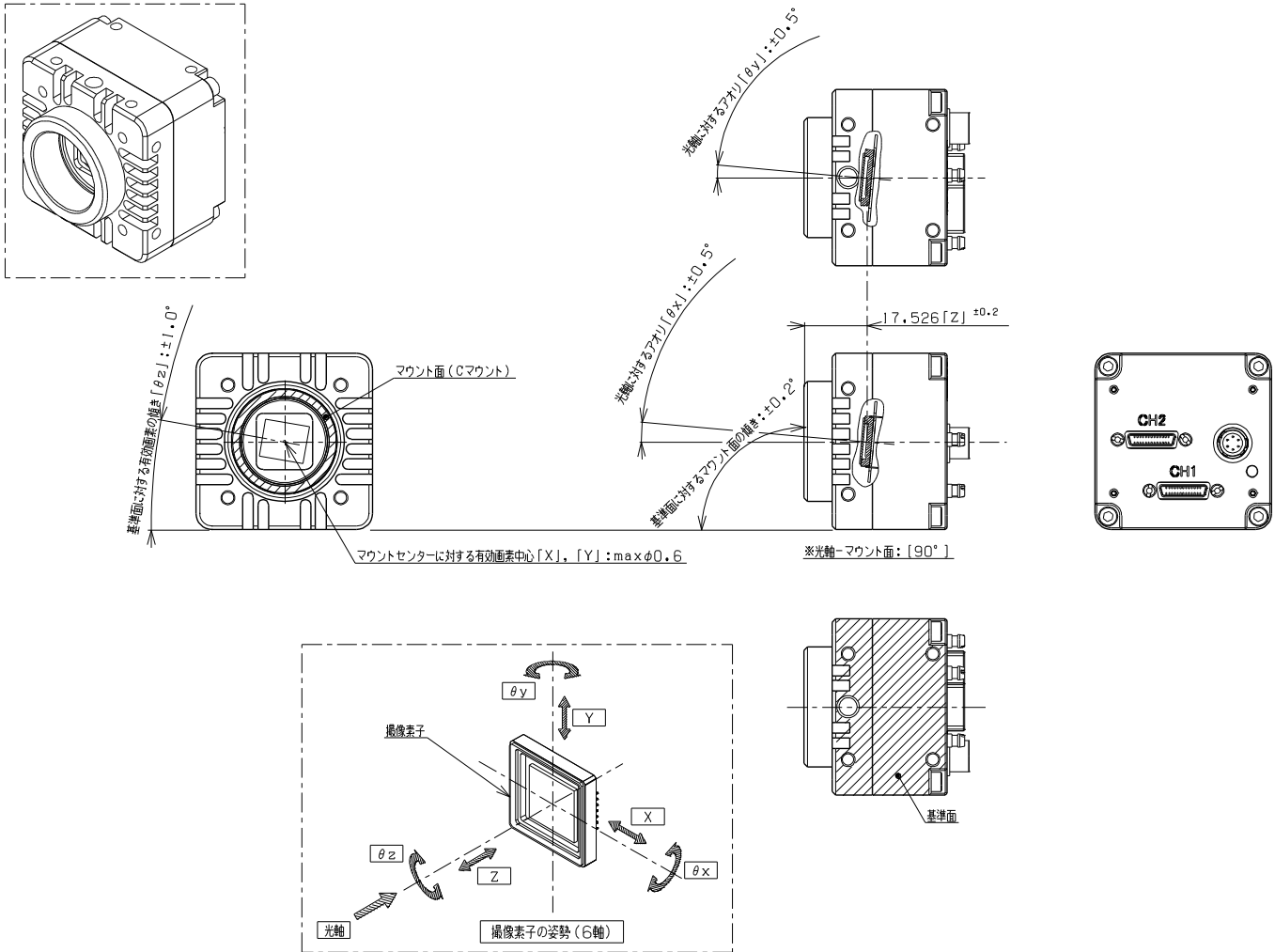

Unit: mm

### III. Camera Installation

During installation of the camera, the following equipment is required:

- Control Software or Serial Communication Software to access the camera register. For more information on using the software, please refer to Section VII: Control Software. For more information on accessing the camera register, please refer to Section VI: The Communication Protocol Specifications.
- Camera Link Cable x 2 (SDR Connector : Camera Side)  
When using on Full Configuration Settings, please insure the cable is up to the qualification required.
- The Frame Grabber being used should be able to support Full, Medium, and Base Camera Link Configuration. When using the PoCL function, please insure the Frame Grabber supports PoCL.

## IV. Camera Output Timing Charts

### A. Horizontal Timing (STC-CMB2MCL / STC-CMC2MCL / STC-CMB4MCL / STC-CMC4MCL)

#### 1. 2 TAPS (1X2-1Y) / Horizontal 2,048 Pixels

1 CLK = 11.764 nseconds (85MHz)  
 1 CLK = 23.524 nseconds (42.5MHz)

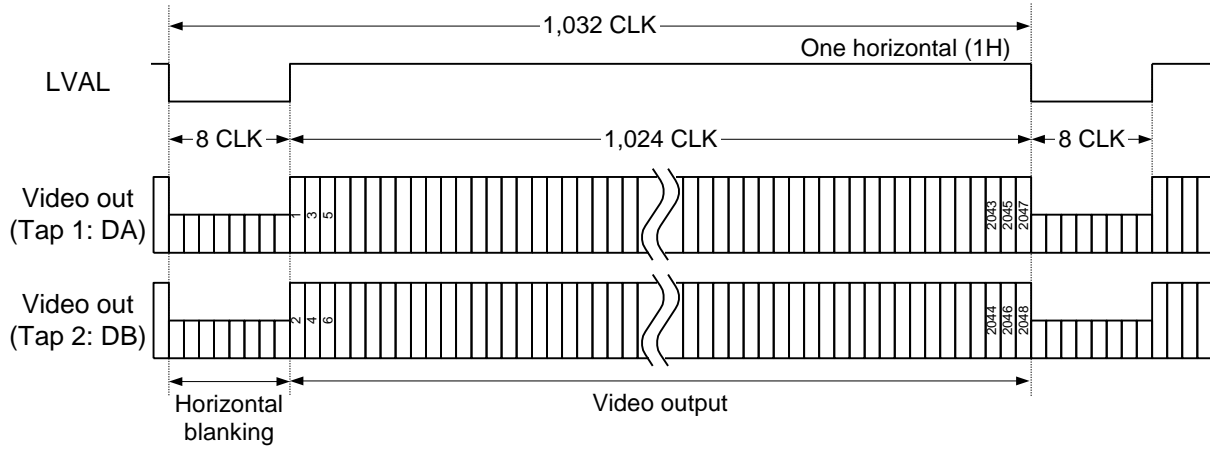

The Pixel Order for the Image

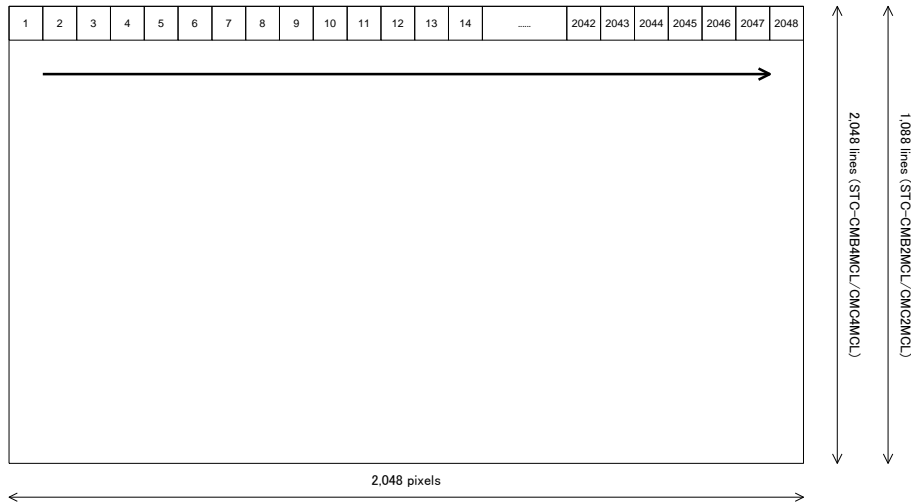

TAP1: DA Output Pixels

1	3	5	7	9	11	13	.....	2035	2037	2039	2041	2043	2045	2047
---	---	---	---	---	----	----	-------	------	------	------	------	------	------	------

TAP2: DB Output Pixels

2	4	6	8	10	12	14	.....	2036	2038	2040	2042	2044	2046	2048
---	---	---	---	----	----	----	-------	------	------	------	------	------	------	------

2. 4 Taps (1X4-1Y) / Horizontal 2,048 Pixels

1 CLK = 11.764 nseconds (85MHz)  
 1 CLK = 23.524 nseconds(42.5MHz)

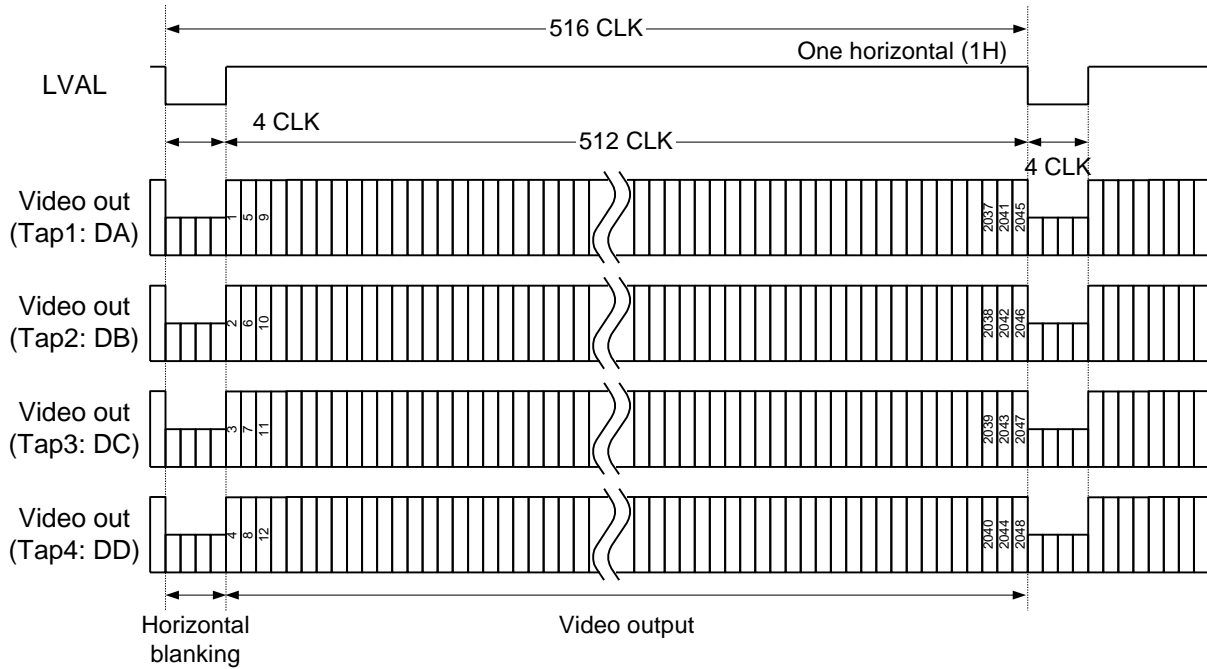

The pixel order for the Image

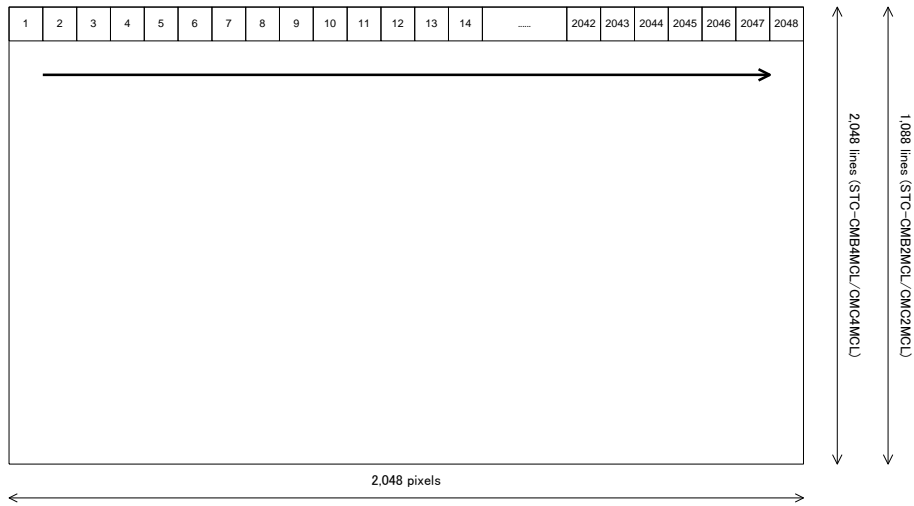

TAP1: DA output pixels

1	5	9	13	17	21	25	.....	2021	2025	2029	2033	2037	2041	2045
---	---	---	----	----	----	----	-------	------	------	------	------	------	------	------

TAP2: DB output pixels

2	6	10	14	18	22	26	.....	2022	2026	2030	2034	2038	2042	2046
---	---	----	----	----	----	----	-------	------	------	------	------	------	------	------

TAP3: DC output pixels

3	7	11	15	19	23	27	.....	2023	2027	2031	2035	2039	2043	2047
---	---	----	----	----	----	----	-------	------	------	------	------	------	------	------

TAP4: DD output pixels

4	8	12	16	20	24	28	.....	2024	2028	2032	2036	2040	2044	2048
---	---	----	----	----	----	----	-------	------	------	------	------	------	------	------

### 3. 8 Taps (1X8-1Y) / Horizontal 2,048 Pixels

1 CLK = 11.764 nseconds (85MHz)  
 1 CLK = 23.524 nseconds (42.5MHz)

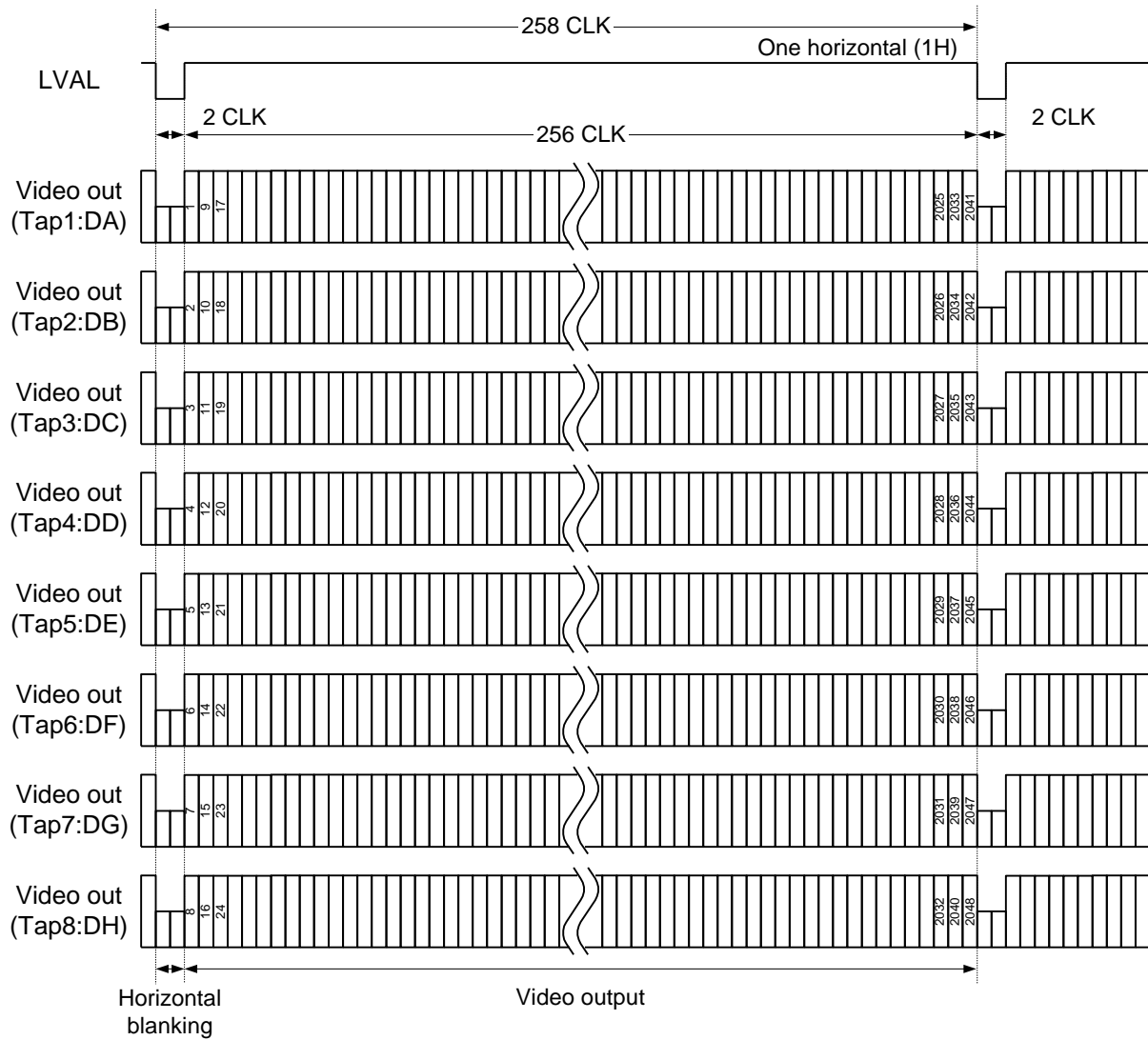

The pixel order for the Image

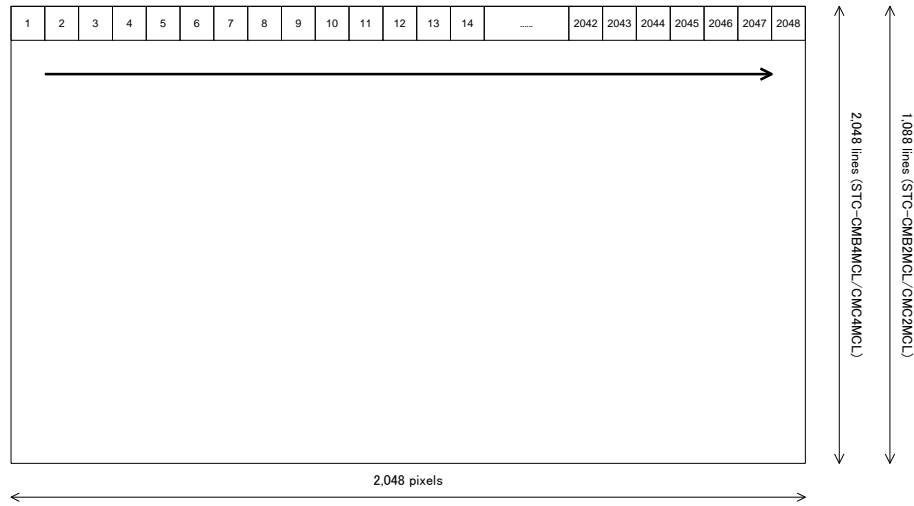

TAP1: DA output pixels

1	9	17	25	33	41	49	.....	1993	2001	2009	2017	2025	2033	2041
---	---	----	----	----	----	----	-------	------	------	------	------	------	------	------

TAP2: DB output pixels

2	10	18	26	34	42	50	.....	1994	2002	2010	2018	2026	2034	2042
---	----	----	----	----	----	----	-------	------	------	------	------	------	------	------

TAP3: DC output pixels

3	11	19	27	35	43	51	.....	1995	2003	2011	2019	2027	2035	2043
---	----	----	----	----	----	----	-------	------	------	------	------	------	------	------

TAP4: DD output pixels

4	12	20	28	36	44	52	.....	1996	2004	2012	2020	2028	2036	2044
---	----	----	----	----	----	----	-------	------	------	------	------	------	------	------

TAP5: DE output pixels

5	13	21	29	37	45	53	.....	1997	2005	2013	2021	2029	2037	2045
---	----	----	----	----	----	----	-------	------	------	------	------	------	------	------

TAP6: DF output pixels

6	14	22	30	38	46	54	.....	1998	2006	2014	2022	2030	2038	2046
---	----	----	----	----	----	----	-------	------	------	------	------	------	------	------

TAP7: DG output pixels

7	15	23	31	39	47	55	.....	1999	2007	2015	2023	2031	2039	2047
---	----	----	----	----	----	----	-------	------	------	------	------	------	------	------

TAP8: DH output pixels

8	16	24	32	40	48	56	.....	2000	2008	2016	2024	2032	2040	2048
---	----	----	----	----	----	----	-------	------	------	------	------	------	------	------



## 4. 10 TAPS (1X10-1Y) / Horizontal 2,040 Pixels

1 CLK = 12.500 nseconds (80MHz)  
 1 CLK = 25.000 nseconds (40MHz)

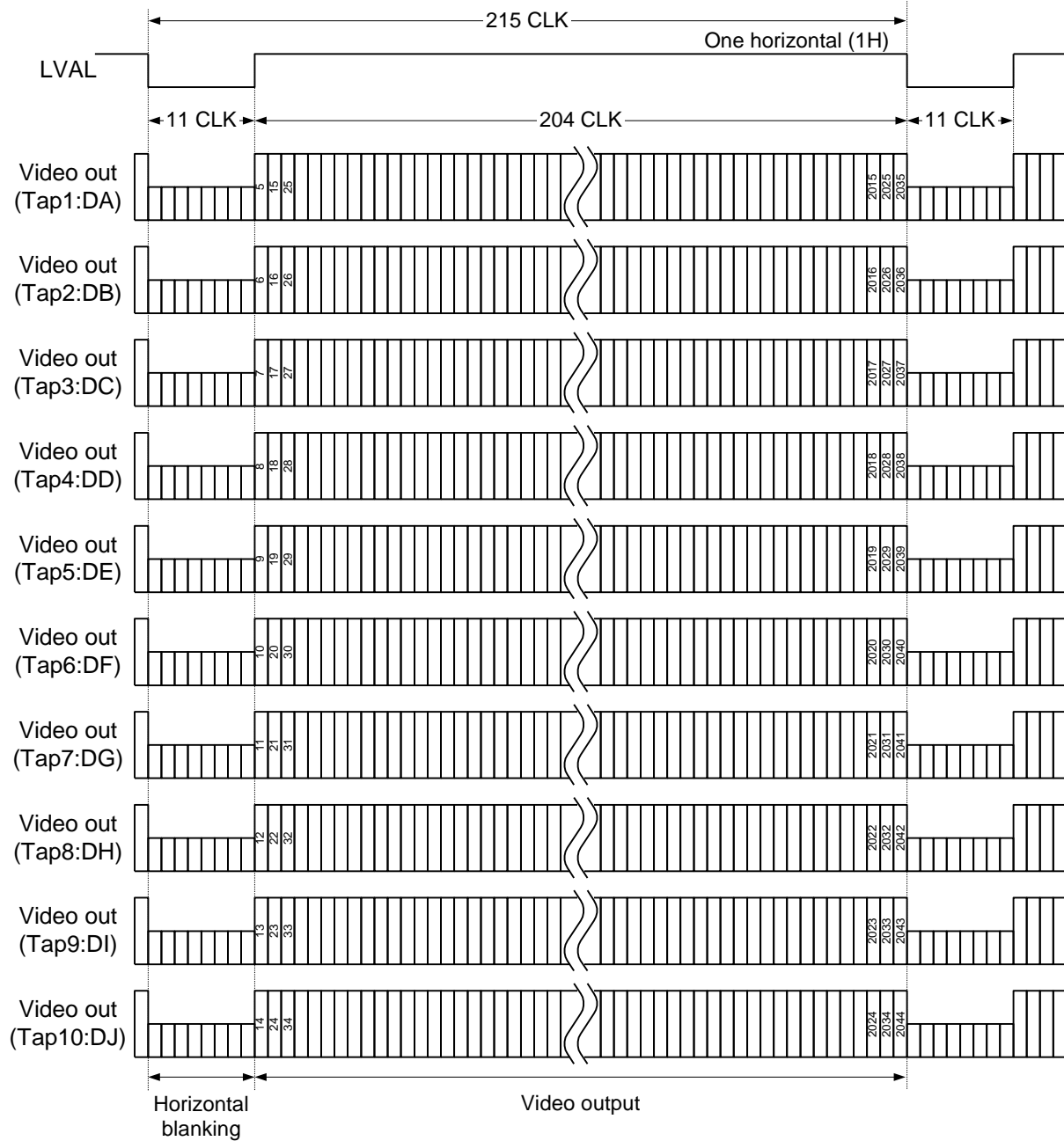

The pixel order for the Image

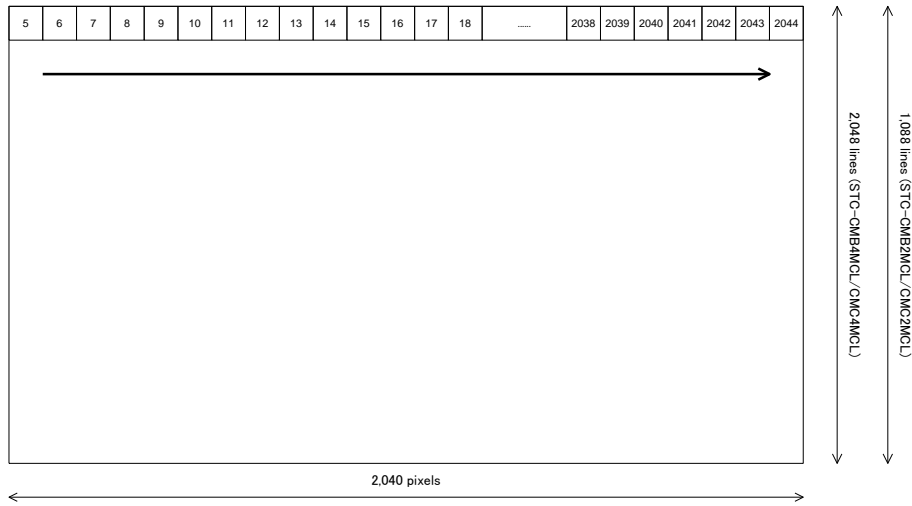

TAP1: DA output pixels	<table border="1"><tr><td>5</td><td>15</td><td>25</td><td>35</td><td>45</td><td>55</td><td>65</td><td>.....</td><td>1975</td><td>1985</td><td>1995</td><td>2005</td><td>2015</td><td>2025</td><td>2035</td></tr></table>	5	15	25	35	45	55	65	.....	1975	1985	1995	2005	2015	2025	2035
5	15	25	35	45	55	65	.....	1975	1985	1995	2005	2015	2025	2035		
TAP2: DB output pixels	<table border="1"><tr><td>6</td><td>16</td><td>26</td><td>36</td><td>46</td><td>56</td><td>66</td><td>.....</td><td>1976</td><td>1986</td><td>1996</td><td>2006</td><td>2016</td><td>2026</td><td>2036</td></tr></table>	6	16	26	36	46	56	66	.....	1976	1986	1996	2006	2016	2026	2036
6	16	26	36	46	56	66	.....	1976	1986	1996	2006	2016	2026	2036		
TAP3: DC output pixels	<table border="1"><tr><td>7</td><td>17</td><td>27</td><td>37</td><td>47</td><td>57</td><td>67</td><td>.....</td><td>1977</td><td>1987</td><td>1997</td><td>2007</td><td>2017</td><td>2027</td><td>2037</td></tr></table>	7	17	27	37	47	57	67	.....	1977	1987	1997	2007	2017	2027	2037
7	17	27	37	47	57	67	.....	1977	1987	1997	2007	2017	2027	2037		
TAP4: DD output pixels	<table border="1"><tr><td>8</td><td>18</td><td>28</td><td>38</td><td>48</td><td>58</td><td>68</td><td>.....</td><td>1978</td><td>1988</td><td>1998</td><td>2008</td><td>2018</td><td>2028</td><td>2038</td></tr></table>	8	18	28	38	48	58	68	.....	1978	1988	1998	2008	2018	2028	2038
8	18	28	38	48	58	68	.....	1978	1988	1998	2008	2018	2028	2038		
TAP5: DE output pixels	<table border="1"><tr><td>9</td><td>19</td><td>29</td><td>39</td><td>49</td><td>59</td><td>69</td><td>.....</td><td>1979</td><td>1989</td><td>1999</td><td>2009</td><td>2019</td><td>2029</td><td>2039</td></tr></table>	9	19	29	39	49	59	69	.....	1979	1989	1999	2009	2019	2029	2039
9	19	29	39	49	59	69	.....	1979	1989	1999	2009	2019	2029	2039		
TAP6: DF output pixels	<table border="1"><tr><td>10</td><td>20</td><td>30</td><td>40</td><td>50</td><td>60</td><td>70</td><td>.....</td><td>1980</td><td>1990</td><td>2000</td><td>2010</td><td>2020</td><td>2030</td><td>2040</td></tr></table>	10	20	30	40	50	60	70	.....	1980	1990	2000	2010	2020	2030	2040
10	20	30	40	50	60	70	.....	1980	1990	2000	2010	2020	2030	2040		
TAP7: DG output pixels	<table border="1"><tr><td>11</td><td>21</td><td>31</td><td>41</td><td>51</td><td>61</td><td>71</td><td>.....</td><td>1981</td><td>1991</td><td>2001</td><td>2011</td><td>2021</td><td>2031</td><td>2041</td></tr></table>	11	21	31	41	51	61	71	.....	1981	1991	2001	2011	2021	2031	2041
11	21	31	41	51	61	71	.....	1981	1991	2001	2011	2021	2031	2041		
TAP8: DH output pixels	<table border="1"><tr><td>12</td><td>22</td><td>32</td><td>42</td><td>52</td><td>62</td><td>72</td><td>.....</td><td>1982</td><td>1992</td><td>2002</td><td>2012</td><td>2022</td><td>2032</td><td>2042</td></tr></table>	12	22	32	42	52	62	72	.....	1982	1992	2002	2012	2022	2032	2042
12	22	32	42	52	62	72	.....	1982	1992	2002	2012	2022	2032	2042		
TAP9: DG output pixels	<table border="1"><tr><td>13</td><td>23</td><td>33</td><td>43</td><td>53</td><td>63</td><td>73</td><td>.....</td><td>1983</td><td>1993</td><td>2003</td><td>2013</td><td>2023</td><td>2033</td><td>2043</td></tr></table>	13	23	33	43	53	63	73	.....	1983	1993	2003	2013	2023	2033	2043
13	23	33	43	53	63	73	.....	1983	1993	2003	2013	2023	2033	2043		
TAP10: DH output pixels	<table border="1"><tr><td>14</td><td>24</td><td>34</td><td>44</td><td>54</td><td>64</td><td>74</td><td>.....</td><td>1984</td><td>1994</td><td>2004</td><td>2014</td><td>2024</td><td>2034</td><td>2044</td></tr></table>	14	24	34	44	54	64	74	.....	1984	1994	2004	2014	2024	2034	2044
14	24	34	44	54	64	74	.....	1984	1994	2004	2014	2024	2034	2044		

## 5. 2 Taps (1X2-1Y) / Horizontal 1,024 Pixels

1 CLK = 11.764 nseconds (85MHz)  
 1 CLK = 23.524 nseconds (42.5MHz)

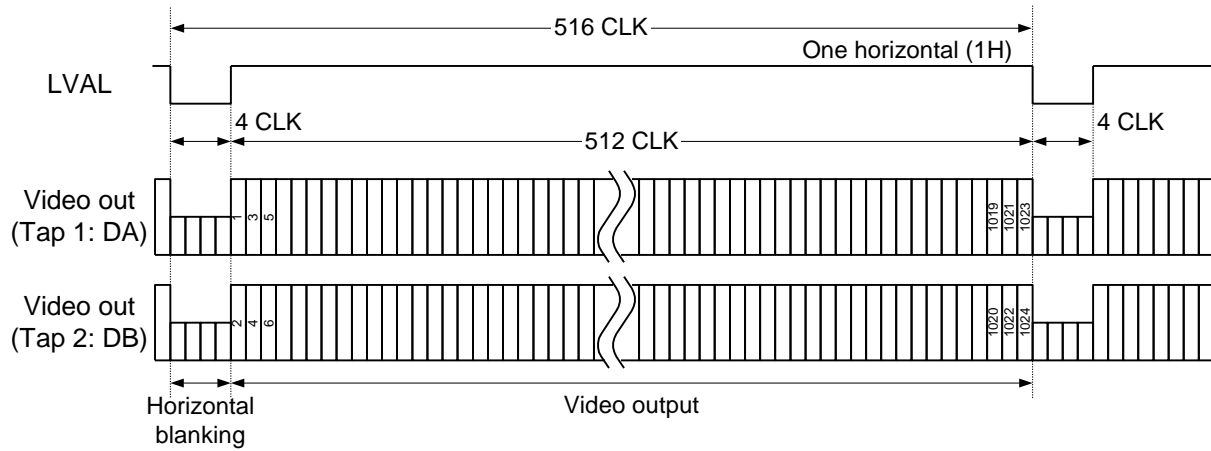

The pixel order for the Image

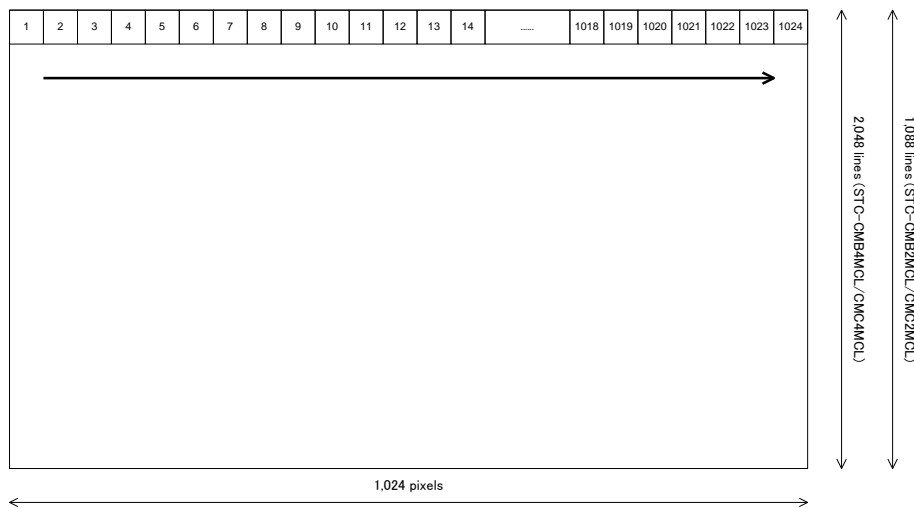

TAP1: DA output pixels

1	3	5	7	9	11	13	.....	1011	1013	1015	1017	1019	1021	1023
---	---	---	---	---	----	----	-------	------	------	------	------	------	------	------

TAP2: DB output pixels

2	4	6	8	10	12	14	.....	1012	1014	1016	1018	1020	1022	1024
---	---	---	---	----	----	----	-------	------	------	------	------	------	------	------

## 6. 2 Taps (1X2-1Y) / Horizontal 512 Pixels

1 CLK = 11.764 nseconds (85MHz)  
 1 CLK = 23.524 nseconds (42.5MHz)

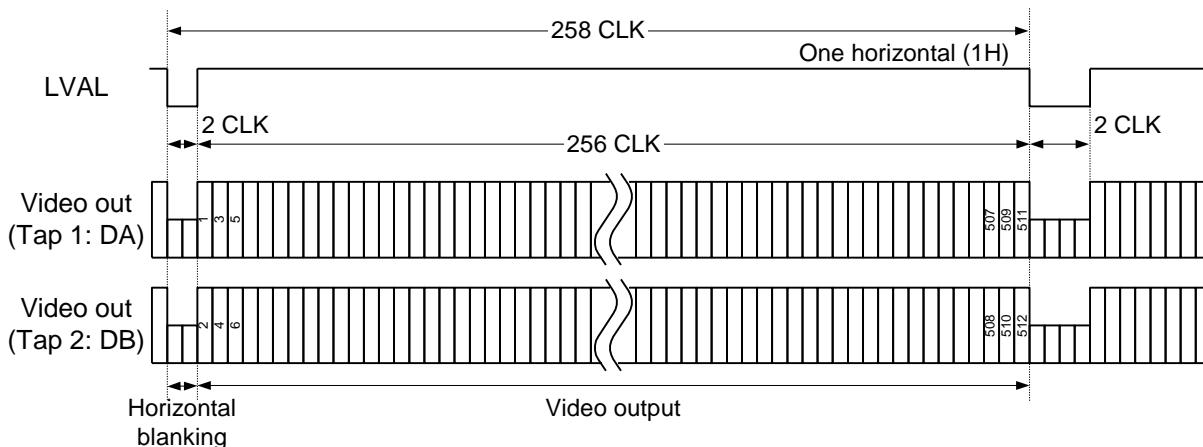

The pixel order for the Image

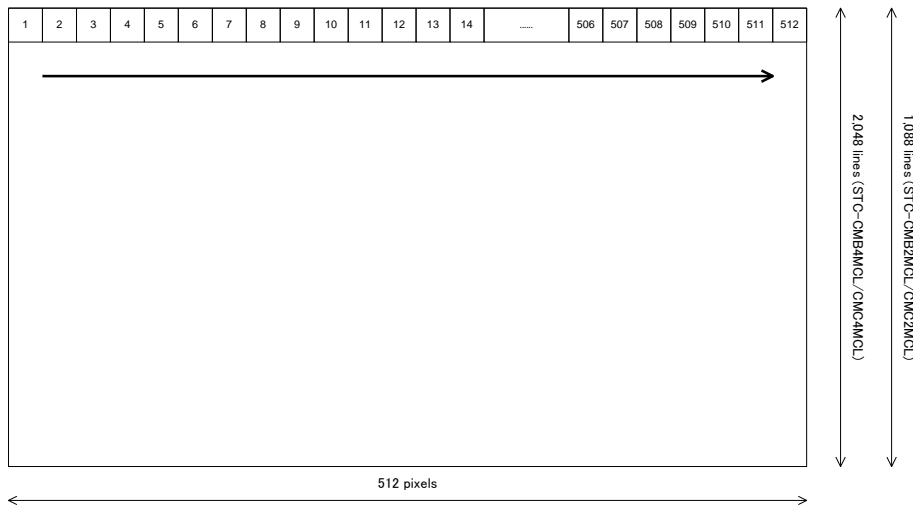

TAP1: DA output pixels

1	3	5	7	9	11	13	.....	499	501	503	505	507	509	511
---	---	---	---	---	----	----	-------	-----	-----	-----	-----	-----	-----	-----

TAP2: DB output pixels

2	4	6	8	10	12	14	.....	500	502	504	506	508	510	512
---	---	---	---	----	----	----	-------	-----	-----	-----	-----	-----	-----	-----

## 7. 4 Taps / Horizontal 1,024 Pixels

1 CLK = 11.764 nseconds (85MHz)  
 1 CLK = 23.524 nseconds (42.5MHz)

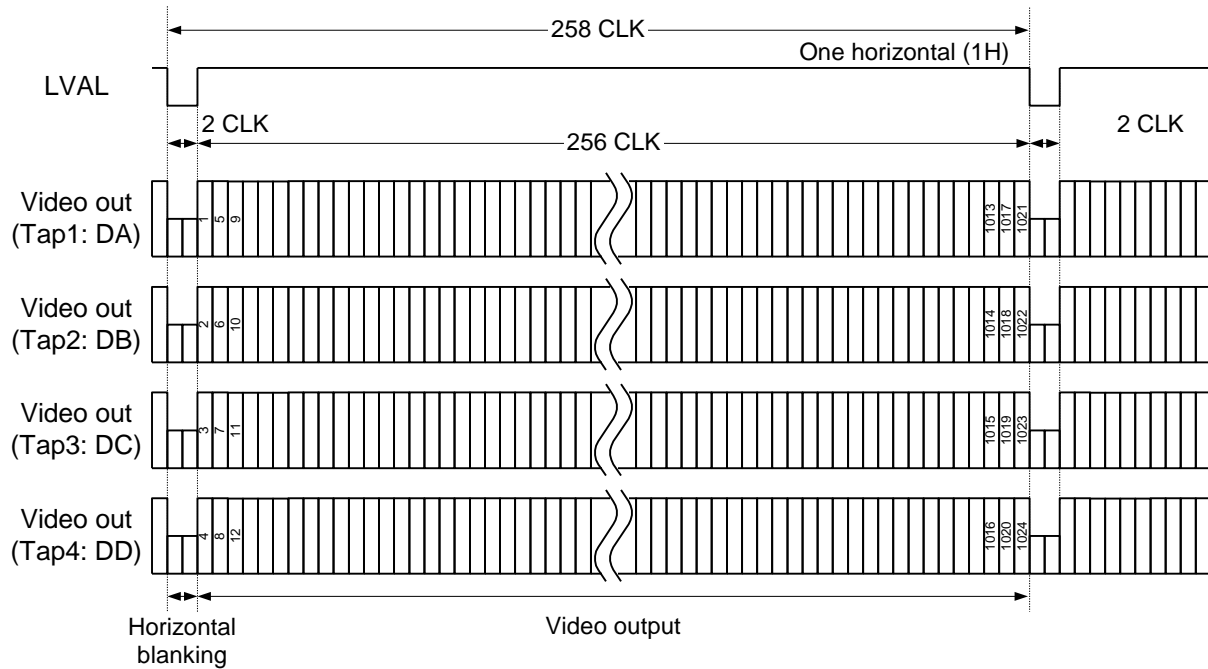

### The pixel order for the Image

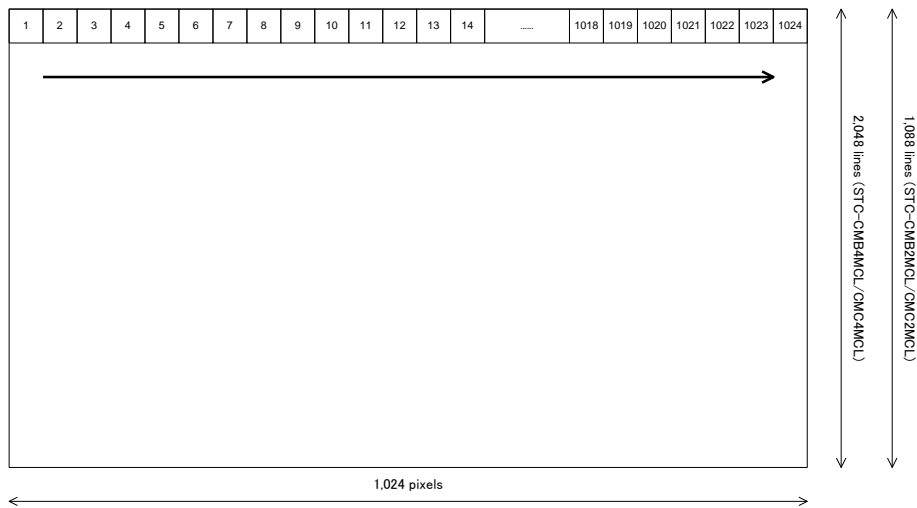

TAP1: DA output pixels

1	5	9	13	17	21	25	.....	997	1001	1005	1009	1013	1017	1021
---	---	---	----	----	----	----	-------	-----	------	------	------	------	------	------

TAP2: DB output pixels

2	6	10	14	18	22	26	.....	998	1002	1006	1010	1014	1018	1022
---	---	----	----	----	----	----	-------	-----	------	------	------	------	------	------

TAP3: DC output pixels

3	7	11	15	19	23	27	.....	999	1003	1007	1011	1015	1019	1023
---	---	----	----	----	----	----	-------	-----	------	------	------	------	------	------

TAP4: DD output pixels

4	8	12	16	20	24	28	.....	1000	1004	1008	1012	1016	1020	1024
---	---	----	----	----	----	----	-------	------	------	------	------	------	------	------

## 8. 2 Taps (1X2-1Y) / 2 x 2 Binning

1 CLK = 11.764 nseconds (85MHz)  
 1 CLK = 23.524 nseconds (42.5MHz)

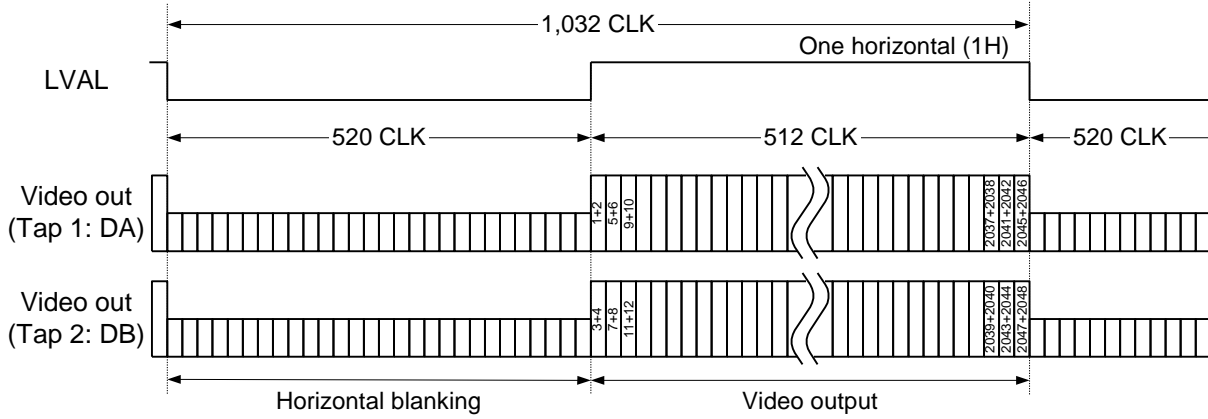

The pixel order for the Image

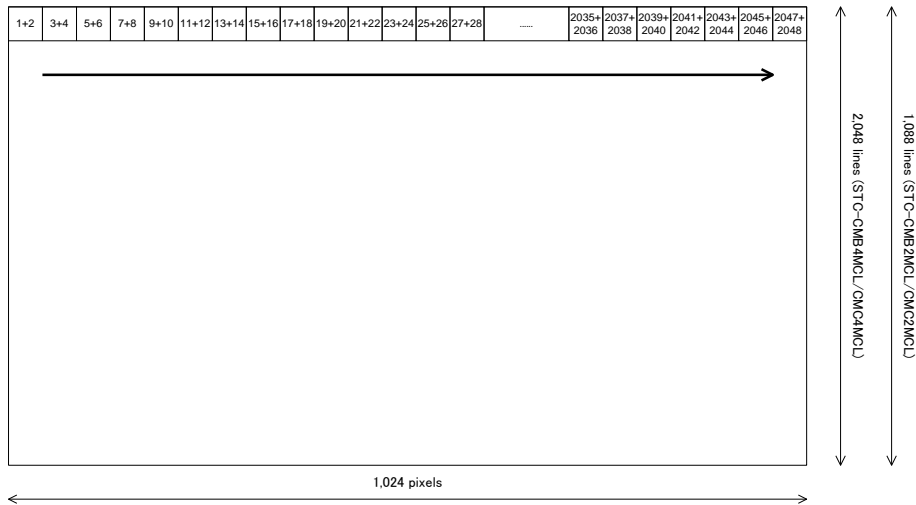

TAP1: DA output pixels

1+2	3+4	5+6	7+8	9+10	13+14	17+18	21+22	25+26	.....	2021+	2025+	2029+	2033+	2037+	2041+	2045+
										2022	2026	2030	2034	2038	2042	2046

TAP2: DB output pixels

3+4	7+8	11+12	15+16	19+20	23+24	27+28	.....	2023+	2027+	2031+	2035+	2039+	2043+	2047+
								2024	2028	2032	2036	2040	2044	2048

## 9. 4 Taps (1X4-1Y) / 2 x 2 Binning

1 CLK = 11.764 nseconds (85MHz)  
 1 CLK = 23.524 nseconds (42.5MHz)

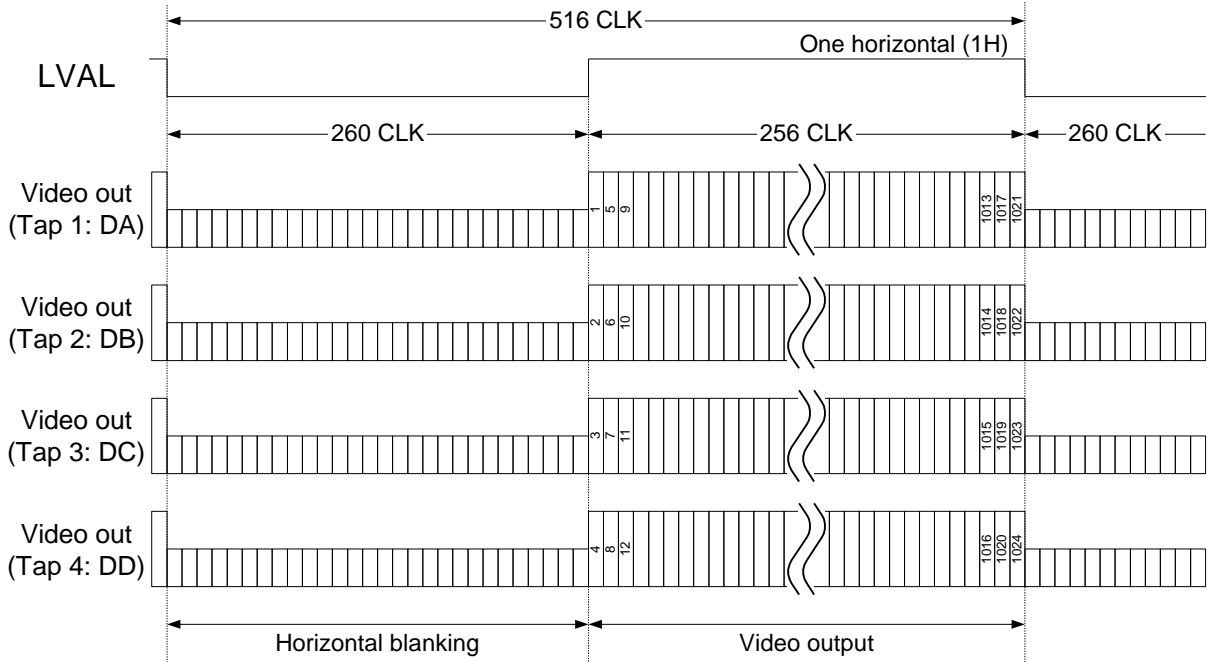

The pixel order for the Image

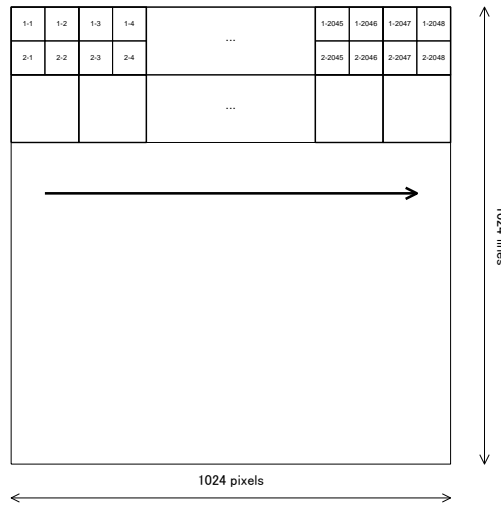

TAP1: DA output pixels	1	5	9	13	17	21	25	.....	997	1001	1005	1009	1013	1017	1021
TAP2: DB output pixels	2	6	10	14	18	22	26	.....	998	1002	1006	1010	1014	1018	1022
TAP3: DC output pixels	3	7	11	15	19	23	27	.....	999	1003	1007	1011	1015	1019	1023
TAP4: DD output pixels	4	8	12	16	20	24	28	.....	1000	1004	1008	1012	1016	1020	1024

## 10. 2 Taps (1X2-1Y) / 4 x 4 Binning

1 CLK = 11.764 nseconds (85MHz)  
 1 CLK = 23.524 nseconds (42.5MHz)

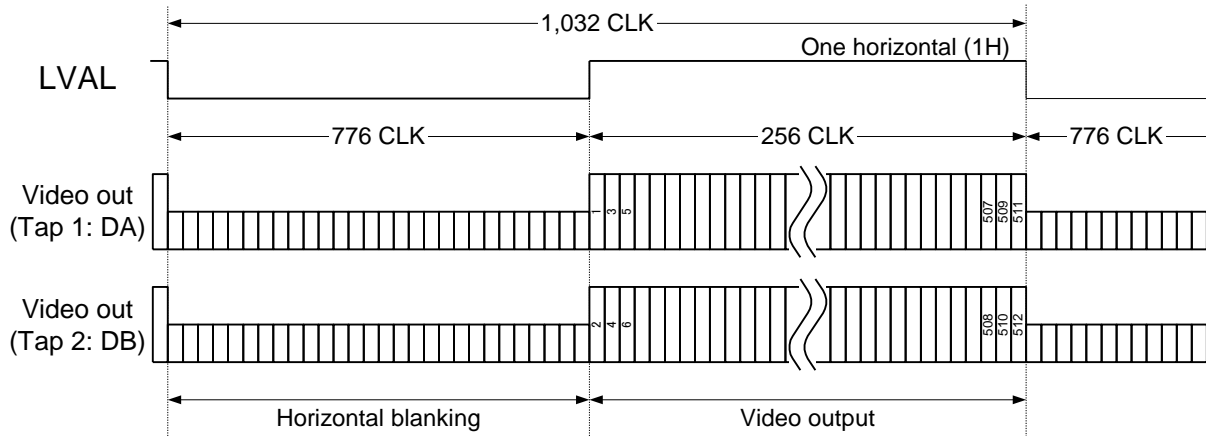

The pixel order for the Image

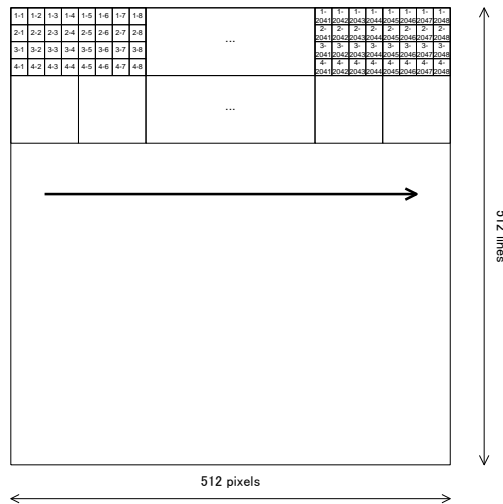

TAP1: DA output pixels 

1	3	5	7	9	11	13	.....	499	501	503	505	507	509	511
---	---	---	---	---	----	----	-------	-----	-----	-----	-----	-----	-----	-----

TAP2: DB output pixels 

2	4	6	8	10	12	14	.....	500	502	504	506	508	510	512
---	---	---	---	----	----	----	-------	-----	-----	-----	-----	-----	-----	-----



## 11. 1 Taps (1X-1Y) / 8 x 8 Binning

1 CLK = 11.764 nseconds (85MHz)  
 1 CLK = 23.524 nseconds (42.5MHz)

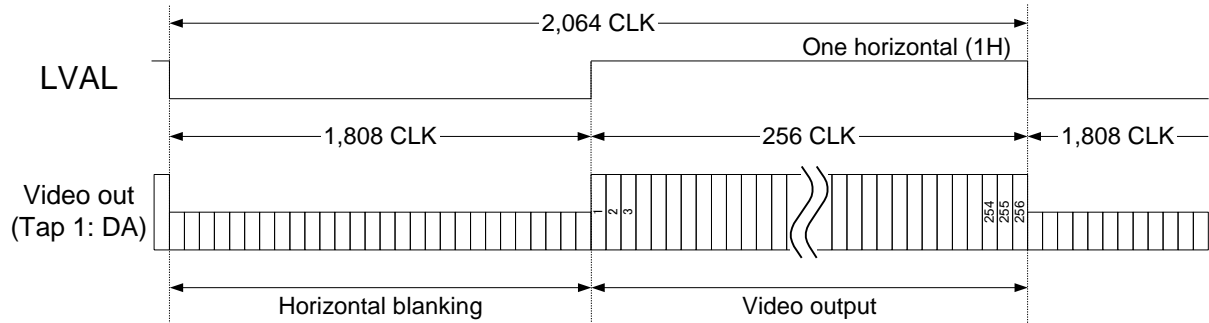

The pixel order for the Image

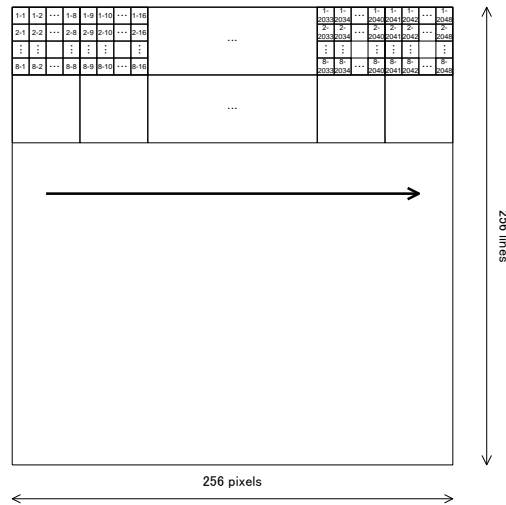

TAP1: DA output pixels

1	2	3	4	5	6	7	.....	250	251	252	253	254	255	256
---	---	---	---	---	---	---	-------	-----	-----	-----	-----	-----	-----	-----

## 12. 2 Taps (1X2-1Y) / 2 x 2 Subsampling

1 CLK = 11.764 nseconds (85MHz)  
 1 CLK = 23.524 nseconds (42.5MHz)

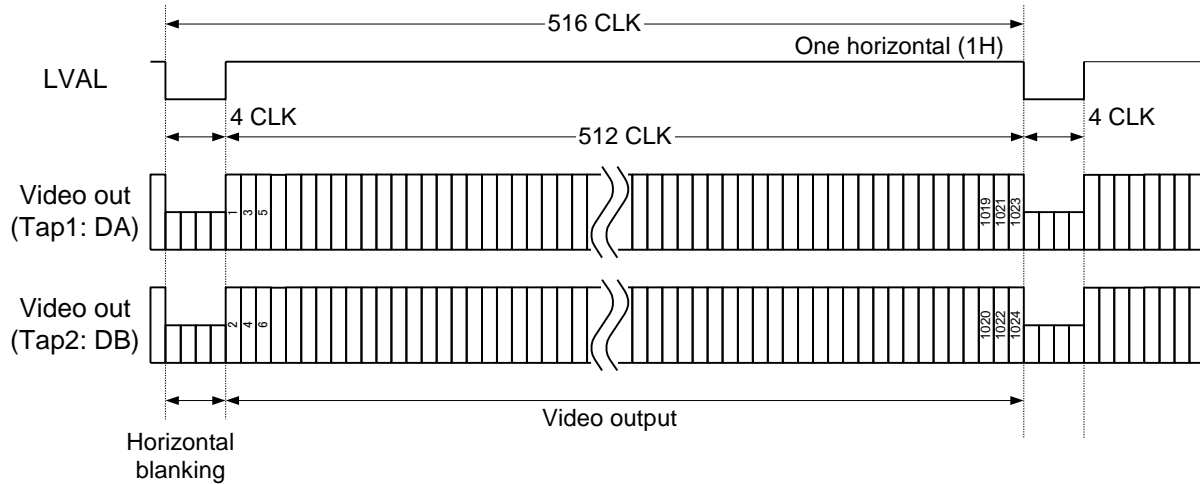

The pixel order for the Image

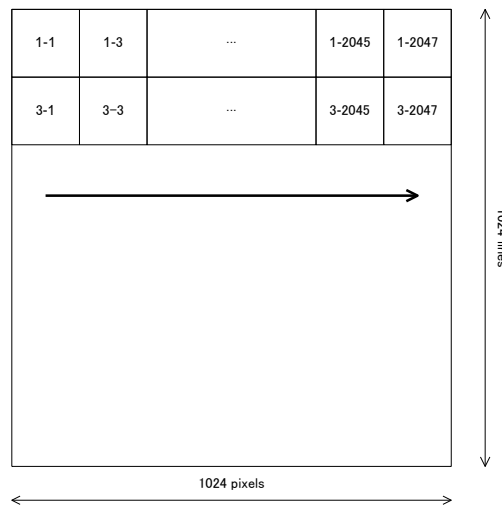

TAP1: DA output pixels

1	3	5	7	9	11	13	...	1011	1013	1015	1017	1019	1021	1023
---	---	---	---	---	----	----	-----	------	------	------	------	------	------	------

TAP2: DB output pixels

2	4	6	8	10	12	14	...	1012	1014	1016	1018	1020	1022	1024
---	---	---	---	----	----	----	-----	------	------	------	------	------	------	------

### 13. 4 Taps (1X4-1Y) / 2 x 2 Subsampling

1 CLK = 11.764 nseconds (85MHz)  
 1 CLK = 23.524 nseconds (42.5MHz)

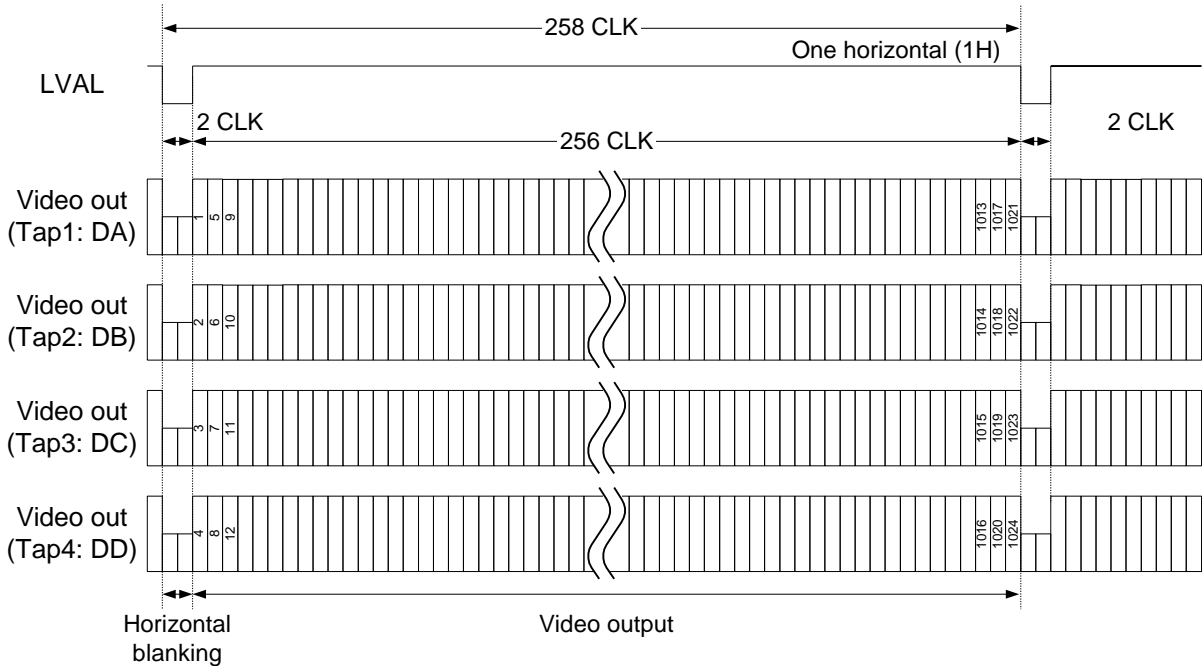

The pixel order for the Image

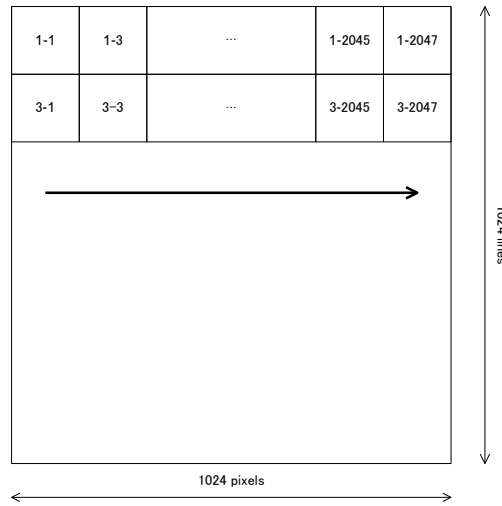

TAP1: DA output pixels	1	5	9	13	17	21	25	.....	997	1001	1005	1009	1013	1017	1021
TAP2: DB output pixels	2	6	10	14	18	22	26	.....	998	1002	1006	1010	1014	1018	1022
TAP3: DC output pixels	3	7	11	15	19	23	27	.....	999	1003	1007	1011	1015	1019	1023
TAP4: DD output pixels	4	8	12	16	20	24	28	.....	1000	1004	1008	1012	1016	1020	1024

## 14. 2 Taps (1X2-1Y) / 4 x 4 Subsampling

1 CLK = 11.764 nseconds (85MHz)  
 1 CLK = 23.524 nseconds (42.5MHz)

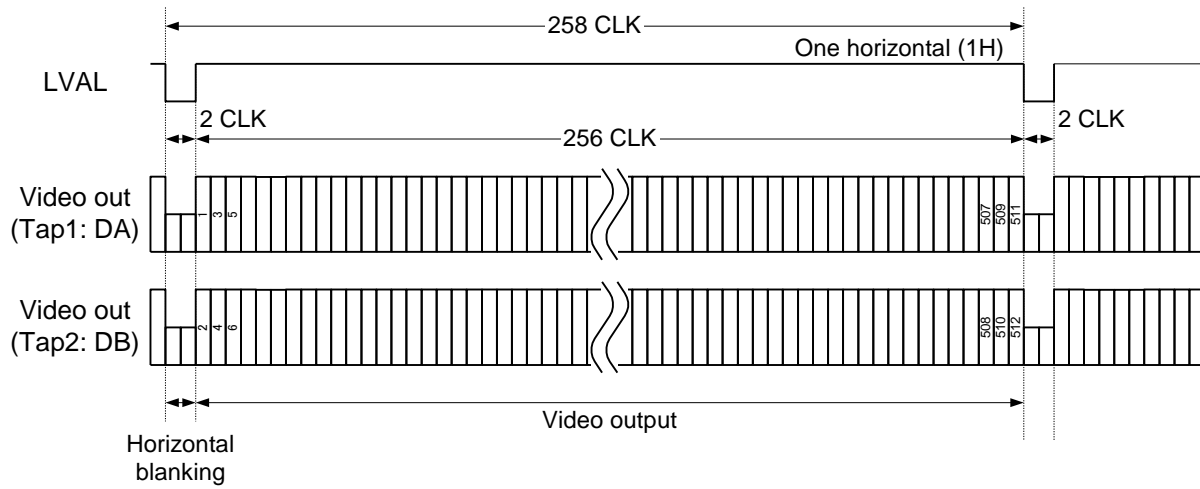

The pixel order for the Image

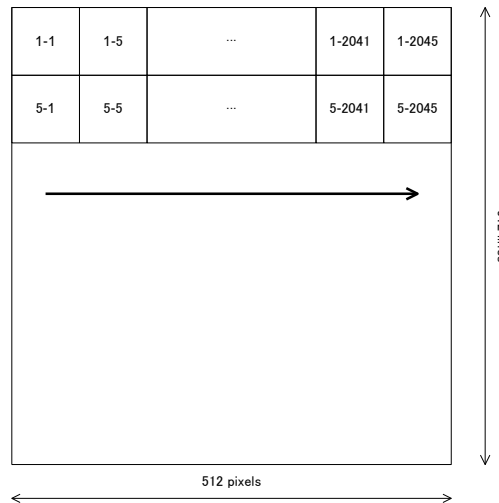

TAP1: DA output pixels

1	3	5	7	9	11	13	.....	499	501	503	505	507	509	511
---	---	---	---	---	----	----	-------	-----	-----	-----	-----	-----	-----	-----

TAP2: DB output pixels

2	4	6	8	10	12	14	.....	500	502	504	506	508	510	512
---	---	---	---	----	----	----	-------	-----	-----	-----	-----	-----	-----	-----

## 15. 1 Taps (1X-1Y) / 8 x 8 Subsampling

1 CLK = 11.764 nseconds (85MHz)  
 1 CLK = 23.524 nseconds (42.5MHz)

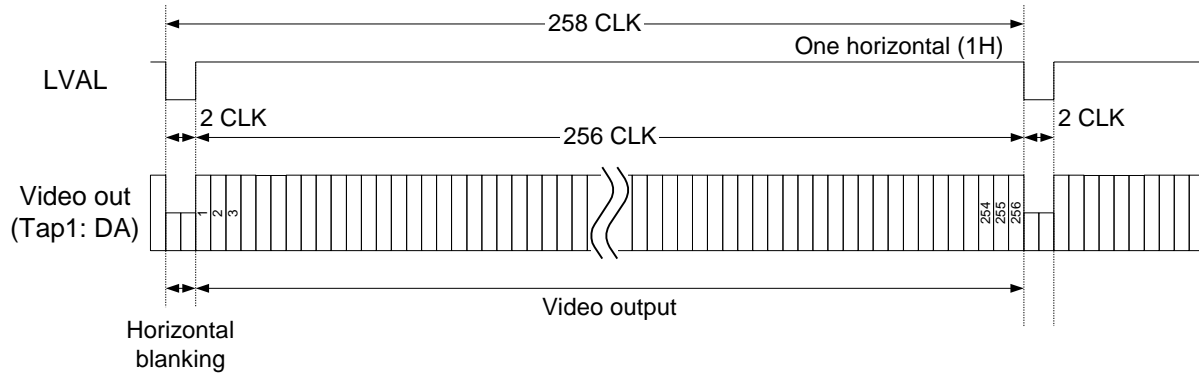

The pixel order for the Image

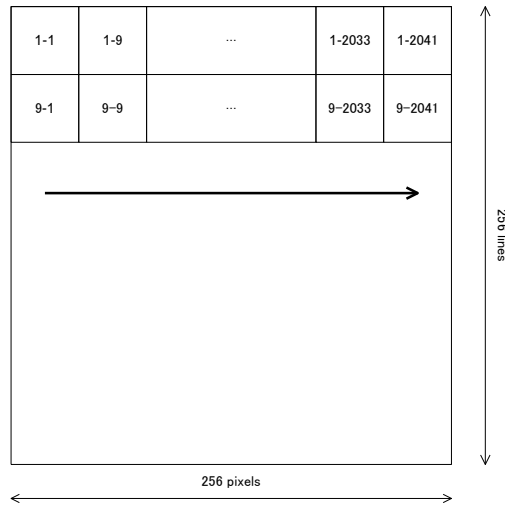

TAP1: DA output pixels

1	2	3	4	5	6	7	.....	250	251	252	253	254	255	256
---	---	---	---	---	---	---	-------	-----	-----	-----	-----	-----	-----	-----

## B. Vertical Timing

Three video scan modes exist. The details for these three scan modes are described below.

Full Scan: All of the lines and pixels output from the camera.

Binning: Averaged pixel value output from the camera.

Subsampling: Skipped the lines and pixels output from the camera.

### Overview of Full Scan Mode:

All of the lines and pixels are output and the entire image is shown. For transmitting the image, some configurations will not be supported, or can drop the frame rate.

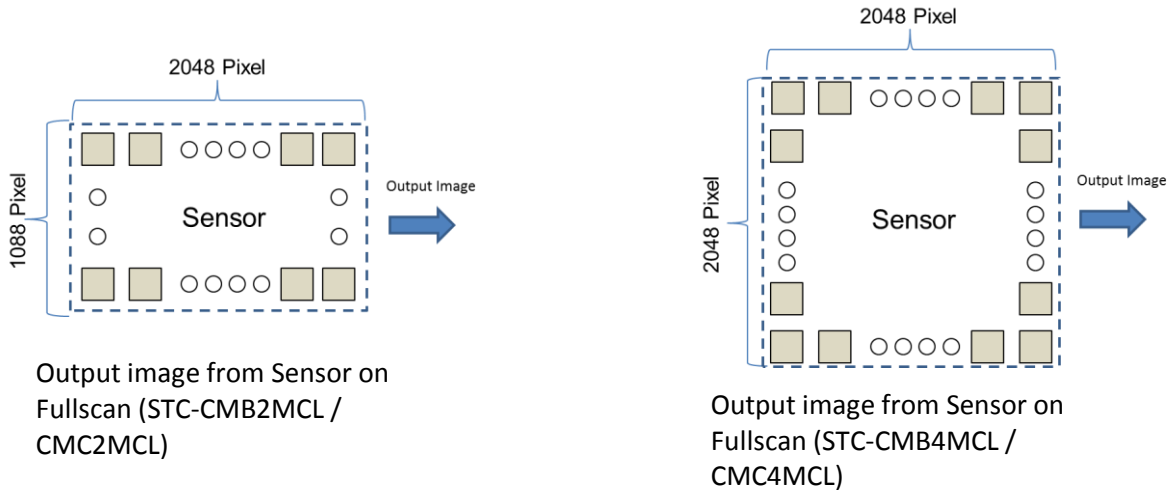

### Overview of Binning (2MP / 4MP):

In this mode, the data of a group of pixels is averaged and output as a one pixel data. Therefore, by selecting this mode the user can reduce the noise level. In this case, instead of averaging the pixel, all subjected pixels black level will increase and affect the dynamic range. Because of this reason, we implemented the averaging method. Resolution will decrease due to the lower number of pixels, however the user can achieve a better noise level and higher frame rate compared to full scan mode.

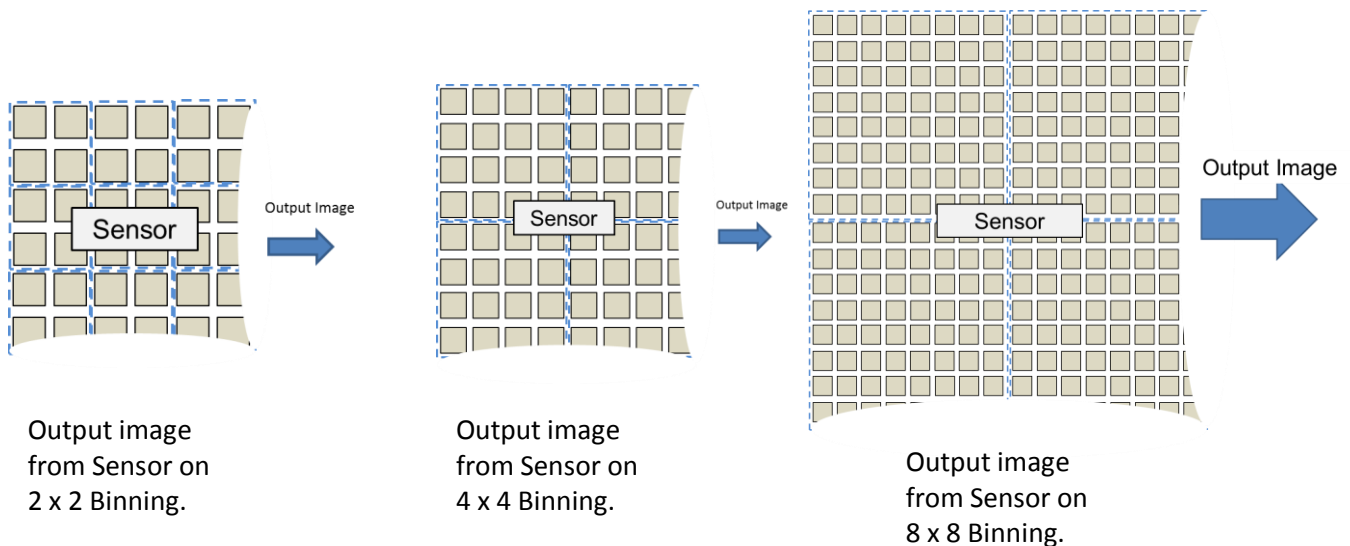

## Overview of Subsampling (2MP / 4MP):

In Subsampling mode, lines and pixel values skip, then are output in the shown image. For skipped pixel data, the resolution will decrease while the frame rate increases. Subsampling reduces the output resolution and increases the frame rate without the FOV (Field of View).

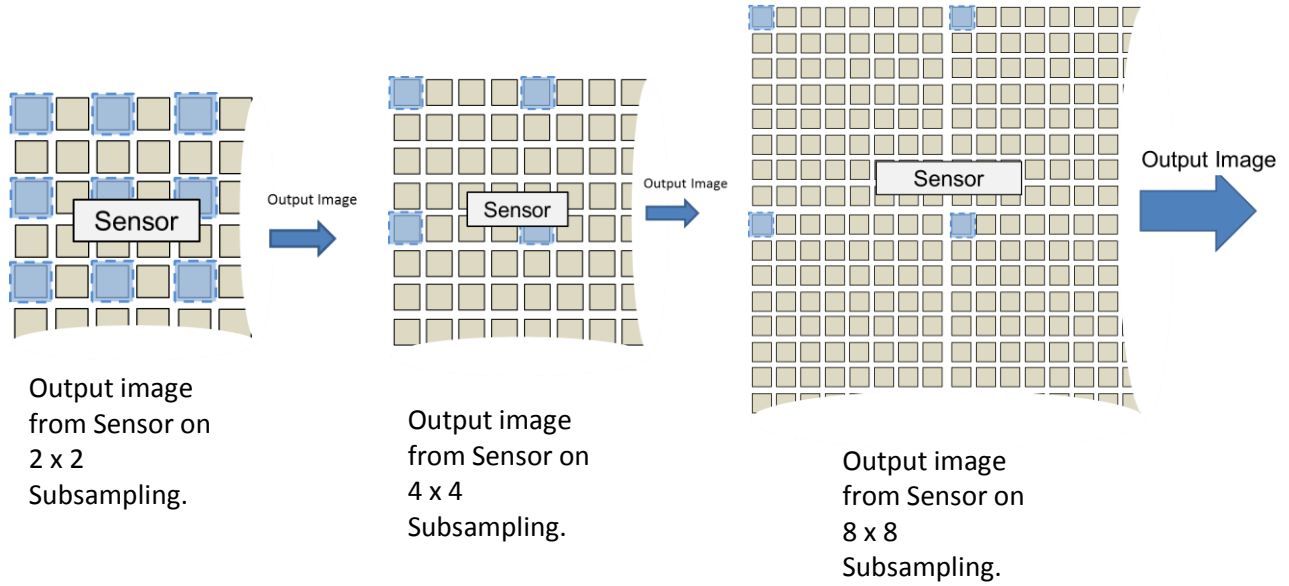

## 1. Full Scan ( STC-CMB2MCL / CMC2MCL)

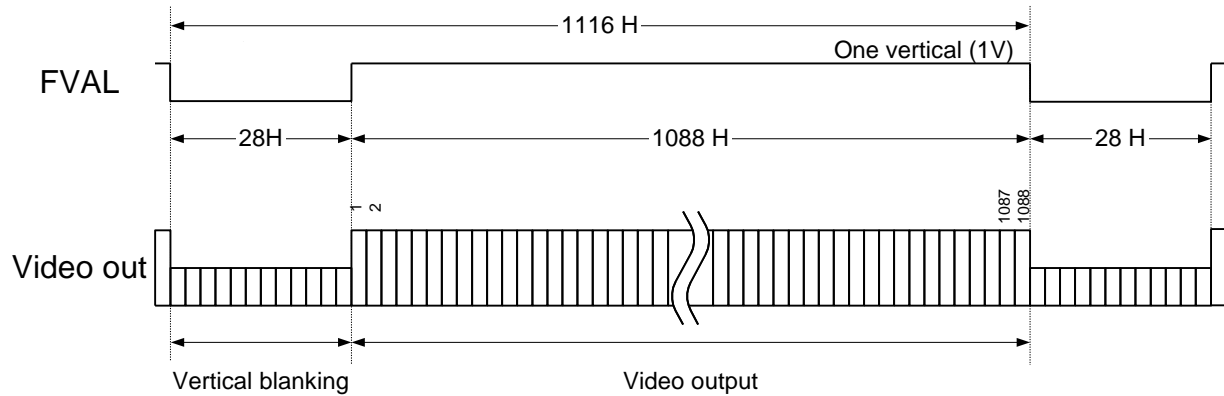

Table of Video Output on Full Scan Mode (STC-CMB2MCL / CMC2MCL)

Mode (29H)	Tap Number	Configuration	CameraLink Output PixelClock Frequency(MHz)	Horizontal Pixel (Pixel)	Sensor Output Pixel Clock(MHz)	FPS	Camera Link Output Bit
0	2	Base	85.0	2048	10.625	73.8	8/10
5	2	Base	85.0	1024	21.250	147.6	8/10
6	2	Base	85.0	512	42.500	295.2	8/10
1	4	MEDIUM	85.0	2048	21.250	147.6	8/10
7	4	MEDIUM	85.0	1024	42.500	295.2	8/10
2	8	FULL	85.0	2048	42.500	295.2	8
3	10		80.0	2040	48.000	333.4	8
0	2	Base	42.5	2048	5.313	36.9	8/10
5	2	Base	42.5	1024	10.625	73.8	8/10
6	2	Base	42.5	512	21.250	147.6	8/10
1	4	MEDIUM	42.5	2048	10.625	73.8	8/10
7	4	MEDIUM	42.5	1024	21.250	147.6	8/10
2	8	FULL	42.5	2048	21.250	147.6	8
3	10		40.0	2040	24.000	166.7	8



## 2. Full Scan (STC-CMB4MCL / CMC4MCL)

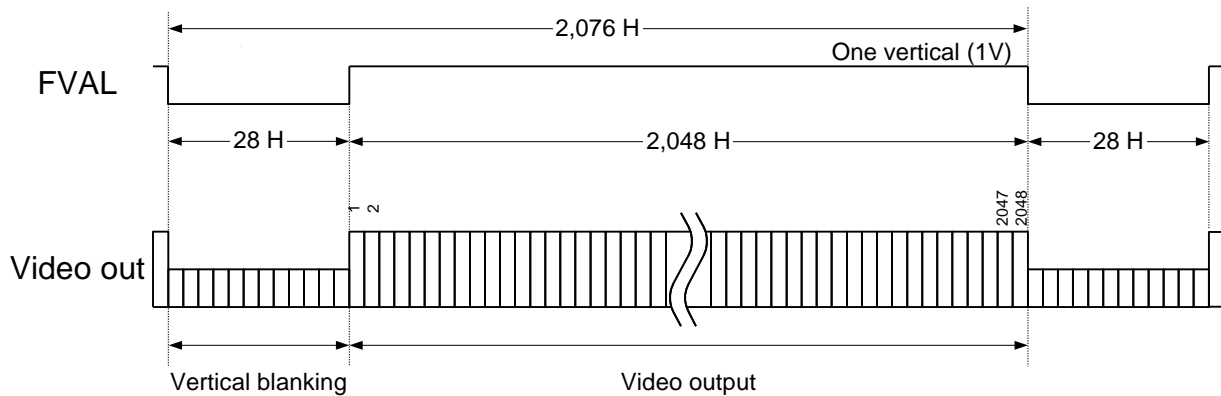
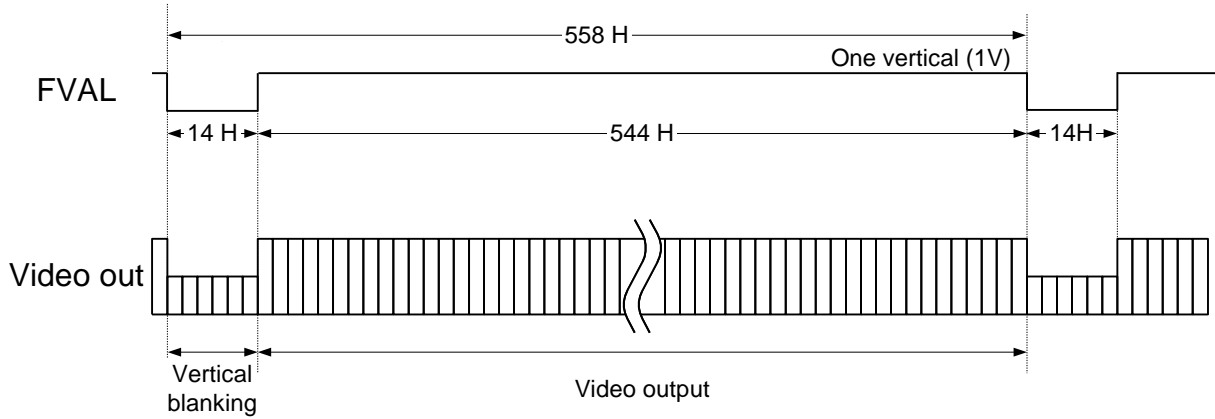

Table of Video Output on Full Scan Mode (STC-CMB4MCL / CMC4MCL)

Mode (29H)	Tap Number	Configuration	CameraLink Output PixelClock Frequency(MHz)	Horizontal Pixel (Pixel)	Sensor Output Pixel Clock(MHz)	FPS	Camera Link Output Bit
0	2	Base	85.0	2048	10.625	39.7	8/10
5	2	Base	85.0	1024	21.250	79.3	8/10
6	2	Base	85.0	512	42.500	158.7	8/10
1	4	Medium	85.0	2048	21.250	79.3	8/10
7	4	Medium	85.0	1024	42.500	158.7	8/10
2	8	Full	85.0	2048	42.500	158.7	8
3	10		80.0	2040	48.000	179.2	8
0	2	Base	42.5	2048	5.313	19.8	8/10
5	2	Base	42.5	1024	10.625	39.7	8/10
6	2	Base	42.5	512	21.250	79.3	8/10
1	4	Medium	42.5	2048	10.625	39.7	8/10
7	4	Medium	42.5	1024	21.250	79.3	8/10
2	8	Full	42.5	2048	21.250	79.3	8
3	10		40.0	2040	24.000	89.6	8

### 3. 2 x 2 Binning (STC-CMB2MCL / CMC2MCL)



### 4. 4 x 4 Binning (STC-CMB2MCL / CMC2MCL)

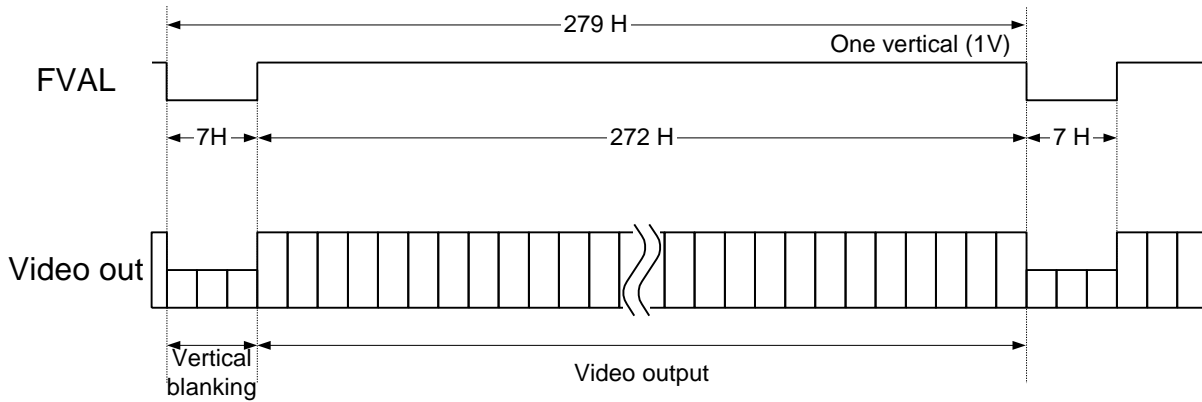

### 5. 8 x 8 Binning (STC-CMB2MCL / CMC2MCL)

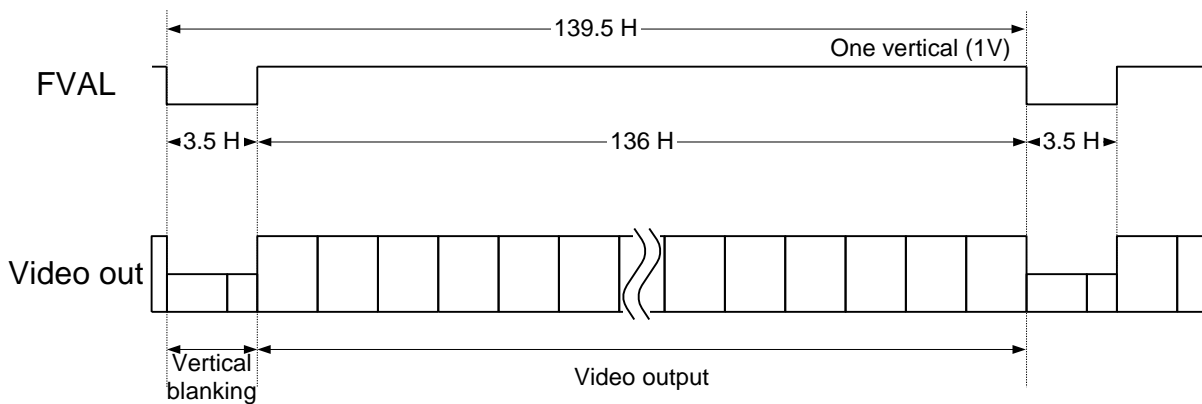
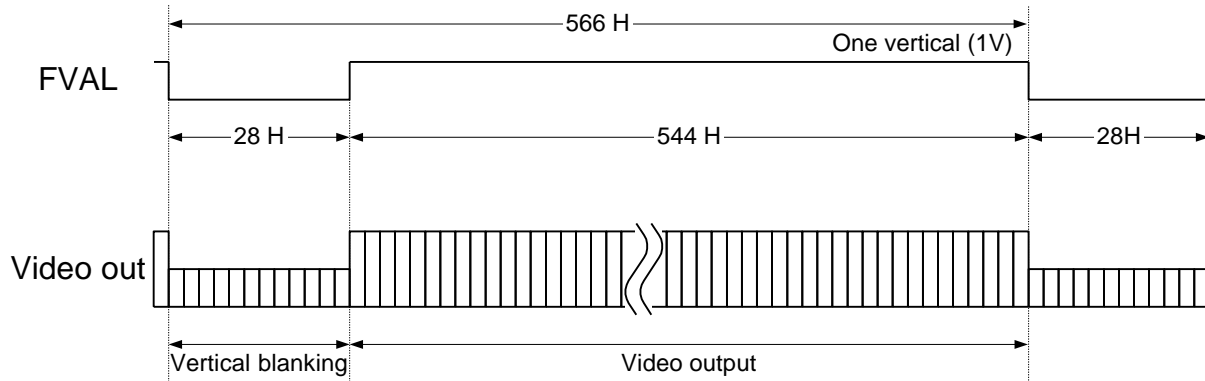

Table of Video Output on Binning Mode (STC-CMB2MCL / CMC2MCL)

Mode (29H)	Tap Number	Binning	Configuration	CameraLink Output PixelClock Frequency(MHz)	Horizontal Pixel (Pixel)	Sensor Output Pixel Clock(MHz)	FPS	Camera Link Output Bit
8	2	2 x 2	Base	85.0	1024	21.250	147.6	8/10/12
10	2	4 x 4	Base	85.0	512	42.500	295.2	8/10/12
9	4	2 x 2	Medium	85.0	1024	42.500	295.2	8/10/12
11	1	8 x 8	Base	85.0	256	42.500	295.2	8/10/12
8	2	2 x 2	Base	42.5	1024	10.625	73.8	8/10/12
10	2	4 x 4	Base	42.5	512	21.250	147.6	8/10/12
9	4	2 x 2	Medium	42.5	1024	21.250	147.6	8/10/12
11	1	8 x 8	Base	42.5	256	21.250	147.6	8/10/12
8	2	2 x 2	Base	85.0	1024	21.250	147.6	8/10/12

### 6. 2 x 2 Subsampling (STC-CMB2MCL / CMC2MCL)



### 7. 4 x 4 Subsampling (STC-CMB2MCL / CMC2MCL)

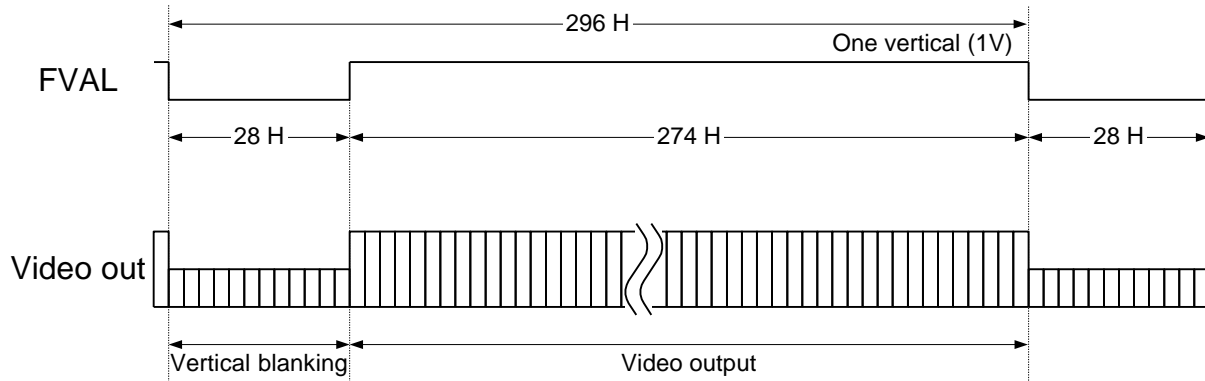

### 8. 8 x 8 Subsampling (STC-CMB2MCL / CMC2MCL)

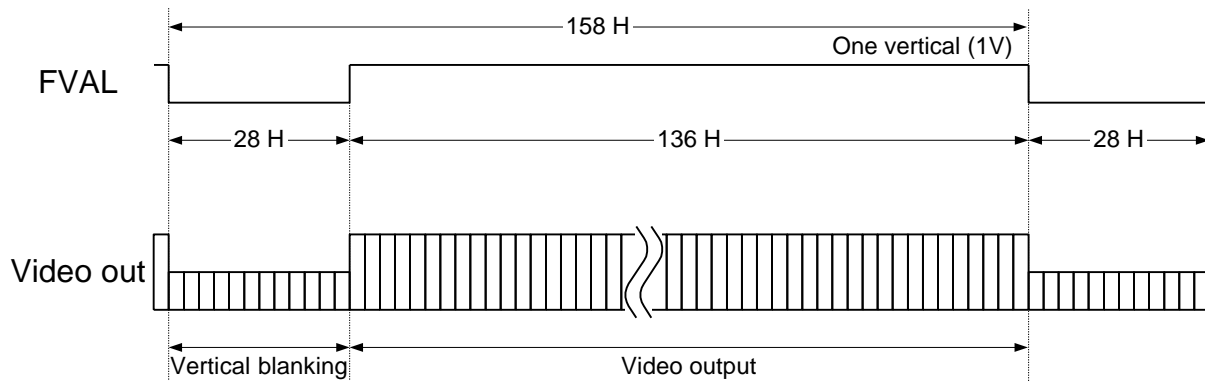
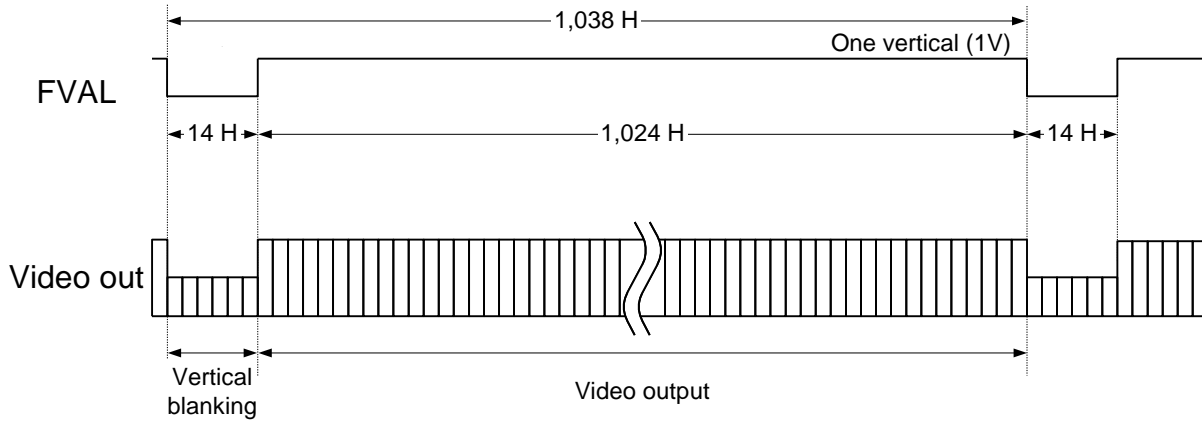

Table of Video Output on Subsampling Mode (STC-CMB2MCL / CMC2MCL)

Subsampling reduces the output resolution and increases the frame rate without FOV (Field of View). This camera has row and column subsampling modes, this mode cannot reduce noise level.

Mode (29H)	Tap Number	Binning	Configuration	CameraLink Output PixelClock Frequency(MHz)	Horizontal Pixel (Pixel)	Sensor Output Pixel Clock(MHz)	FPS	Camera Link Output Bit
12	2	2 x 2	Base	85.0	1024	21.250	288.0	8/10
14	2	4 x 4	Base	85.0	512	42.500	1098.2	8/10
13	4	2 x 2	Medium	85.0	1024	42.500	576.0	8/10
15	1	8 x 8	Base	85.0	256	42.500	2008.9	8/10
12	2	2 x 2	Base	42.5	1024	10.625	144.0	8/10
14	2	4 x 4	Base	42.5	512	21.250	549.1	8/10
13	4	2 x 2	Medium	42.5	1024	21.250	288.0	8/10
15	1	8 x 8	Base	42.5	256	21.250	1004.4	8/10

### 9. 2 x 2 Binning (STC-CMB4MCL / STC-CMC4MCL)



### 10 .4 x 4 Binning (STC-CMB4MCL / CMC4MCL)

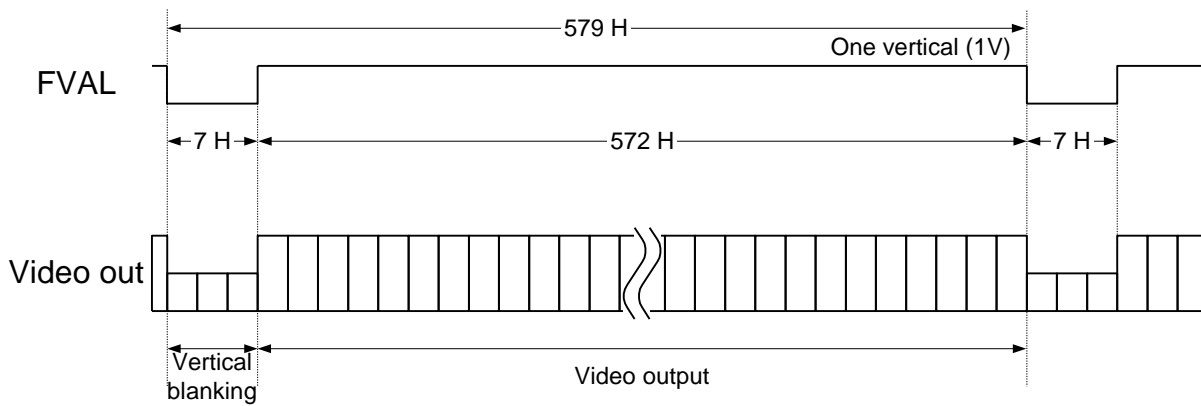

### 11. 8 x 8 Binning (STC-CMB4MCL / CMC4MCL)

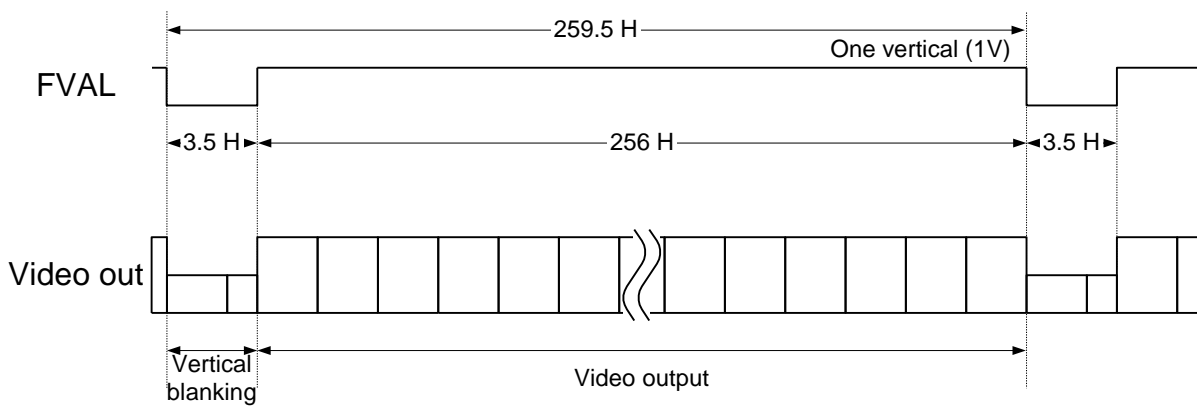
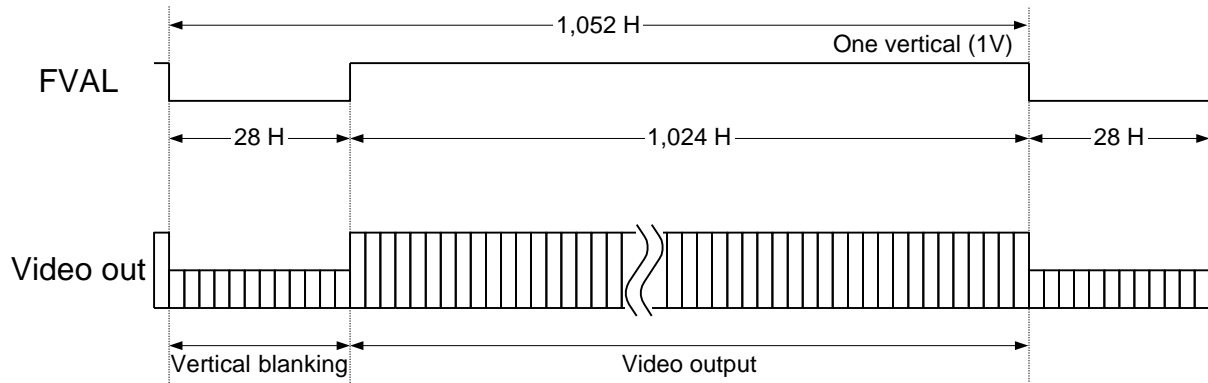

Table of Video Output on Binning Mode (STC-CMB4MCL / CMC4MCL)

Mode (29H)	Tap Number	Binning	Configuration	CameraLink Output PixelClock Frequency(MHz)	Horizontal Pixel (Pixel)	Sensor Output Pixel Clock(MHz)	FPS	Camera Link Output Bit
8	2	2 x 2	Base	85.0	1024	21.250	79.3	8/10/12
10	2	4 x 4	Base	85.0	512	42.500	158.7	8/10/12
9	4	2 x 2	Medium	85.0	1024	42.500	158.7	8/10/12
11	1	8 x 8	Base	85.0	256	42.500	158.7	8/10/12
8	2	2 x 2	Base	42.5	1024	10.625	39.7	8/10/12
10	2	4 x 4	Base	42.5	512	21.250	79.3	8/10/12
9	4	2 x 2	Medium	42.5	1024	21.250	79.3	8/10/12
11	1	8 x 8	Base	42.5	256	21.250	79.3	8/10/12

## 12. 2 x 2 Subsampling (STC-CMB4MCL / CMC4MCL)



## 13. 4 x 4 Subsampling (STC-CMB4MCL / CMC4MCL)

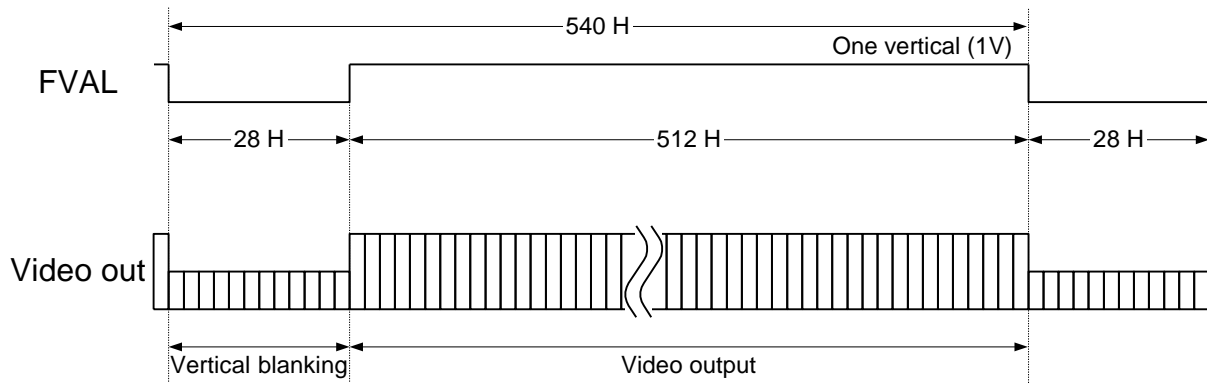

## 14. 8 x 8 Subsampling (STC-CMB4MCL / CMC4MCL)

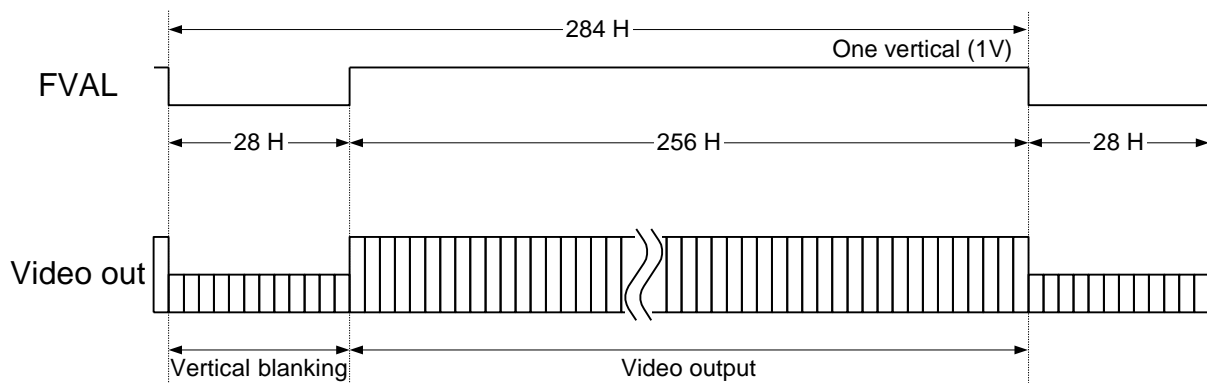

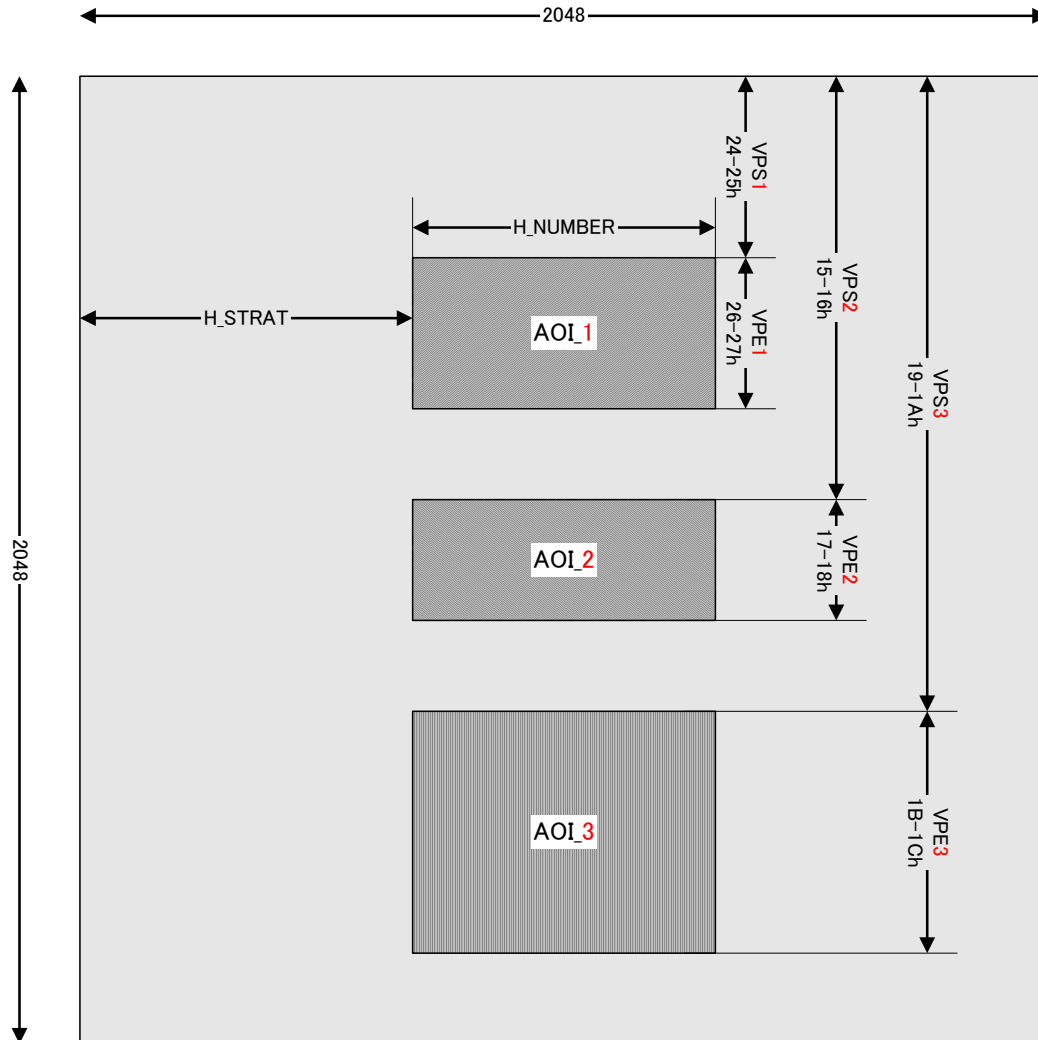

Table of Video Output on Subsampling mode (STC-CMB4MCL / CMC4MCL)

Mode (29H)	Tap Number	Binning	Configuration	CameraLink Output PixelClock Frequency(MHz)	Horizontal Pixel (Pixel)	Sensor Output Pixel Clock(MHz)	FPS	Camera Link Output Bit
12	2	2 x 2	Base	85.0	1024	21.250	156.6	8/10
14	2	4 x 4	Base	85.0	512	42.500	610.1	8/10
13	4	2 x 2	Medium	85.0	1024	42.500	313.2	8/10
15	1	8 x 8	Base	85.0	256	42.500	1160.1	8/10
12	2	2 x 2	Base	42.5	1024	10.625	78.3	8/10
14	2	4 x 4	Base	42.5	512	21.250	305.1	8/10
13	4	2 x 2	Medium	42.5	1024	21.250	156.6	8/10
15	1	8 x 8	Base	42.5	256	21.250	580.0	8/10

### C. AOI Timing

- This camera can set up to 8 AOI.
- AOI can be set with the Binning and Subsampling at the same time.
- The setting of the horizontal effective pixel and the horizontal effective pixels of changeable DVAL are different from each Camera Link output TAP number.
- The horizontal AOI can be controlled by LVAL and DVAL. The Video signal outputs directly, therefore the frame cannot increase in this mode.



#### The Horizontal Effective Pixel

Register[4CH,4DH2-0] = H\_STRAT: Horizontal start position ÷ Output TAP number ÷ Binning or Subsampling number

#### The Horizontal Effective Pixels of Changeable DVAL

Register[4EH,4FH2-0] = H\_NUMBER: Horizontal available pixel number ÷ Output TAP number ÷ Binning or Subsampling number

**When using the 10 TAP, horizontal pixel number is 2040 pixel using H\_STRAT: Horizontal start position -4.**

Register[4EH,4FH2-0] = (H\_NUMBER: Horizontal available pixel number - 4) ÷ Output TAP number ÷ Binning or Subsampling number

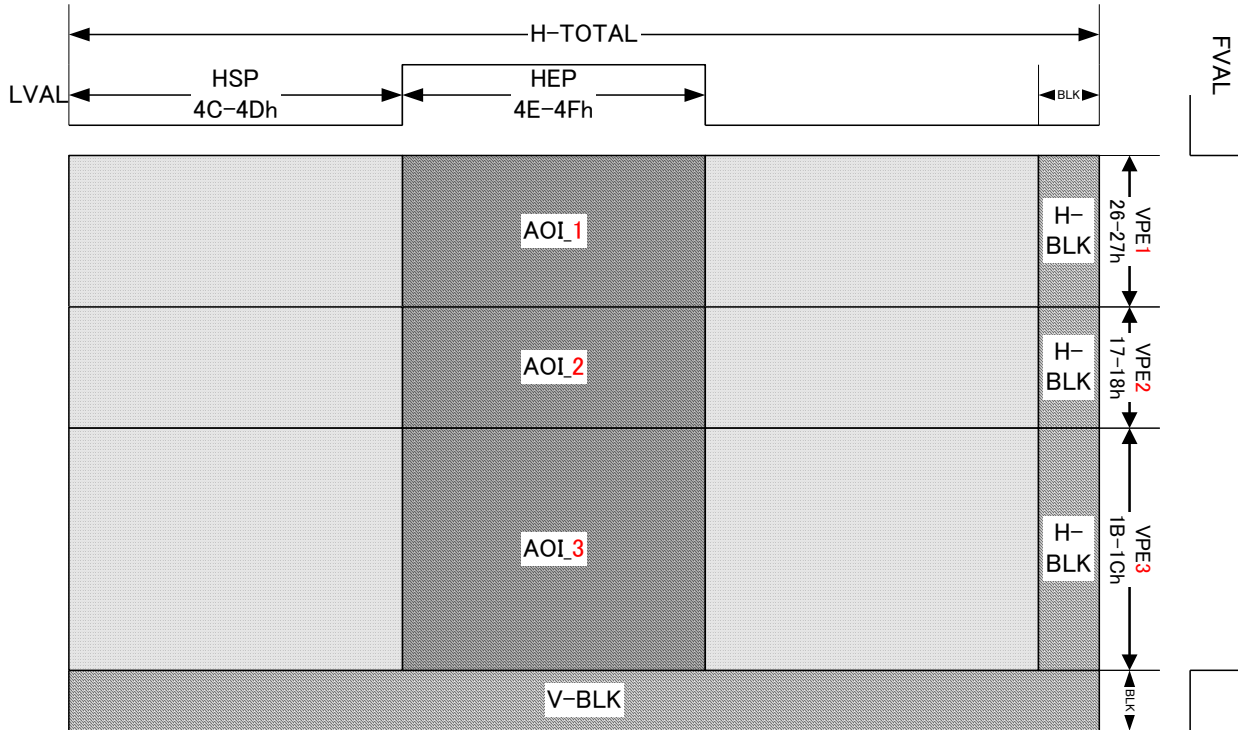

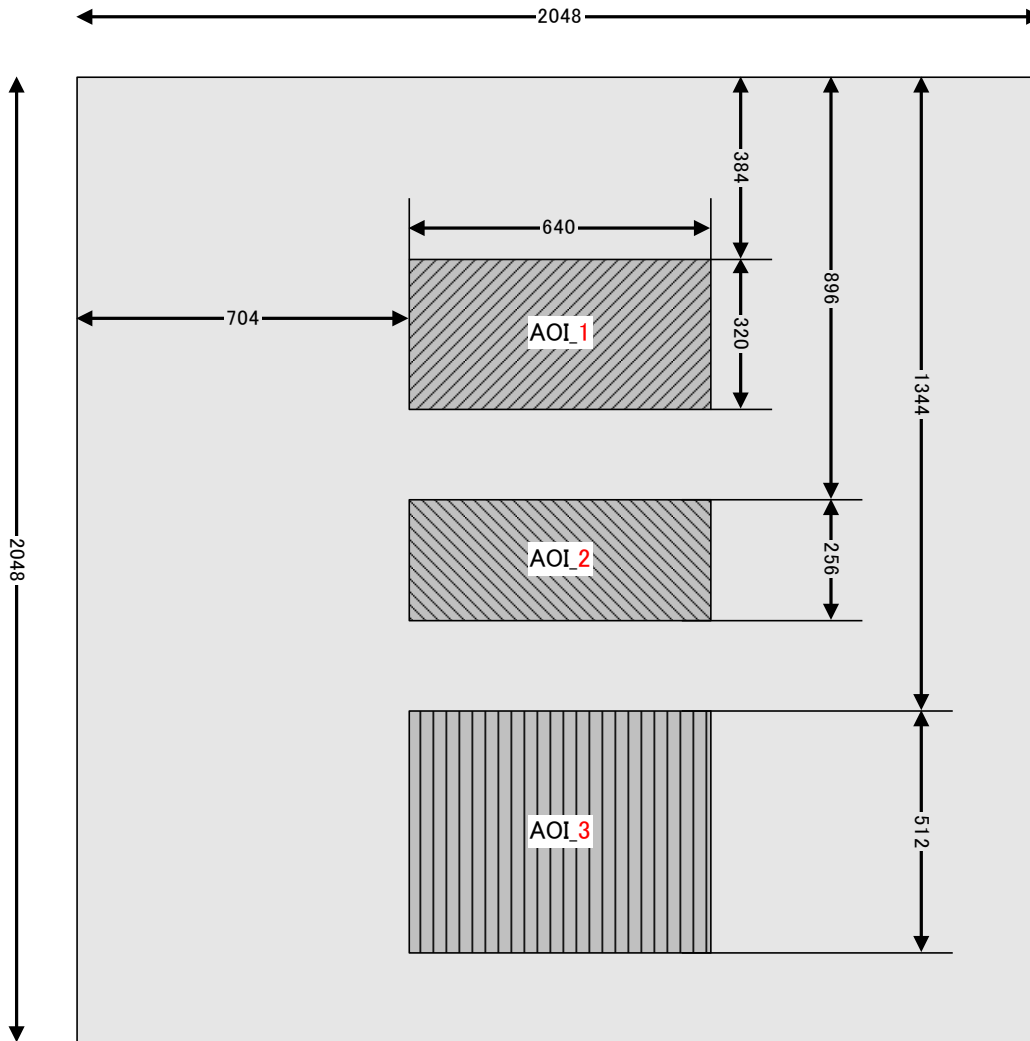

e.g.

H\_STRAT: Horizontal start position = 704

H\_NUMBER: Horizontal available pixel number = 640

On 8TAP

### The horizontal effective pixel

$$\begin{aligned} \text{Register}[4\text{CH},4\text{DH}2-0] &= \text{H\_STRAT: Horizontal start position} \div \text{Output TAP number} \div \text{Binning or Subsampling number} \\ &= 704 \div 8 \div 1 = 88 \end{aligned}$$

### The horizontal effective pixels of changeable DVAL

$$\begin{aligned} \text{Register}[4\text{EH},4\text{FH}2-0] &= \text{H\_NUMBER: Horizontal available pixel number} \div \text{Output TAP number} \div \text{Binning or Subsampling number} \\ &= 640 \div 8 \div 1 = 80 \end{aligned}$$

## D. Camera Link Bit Assignment

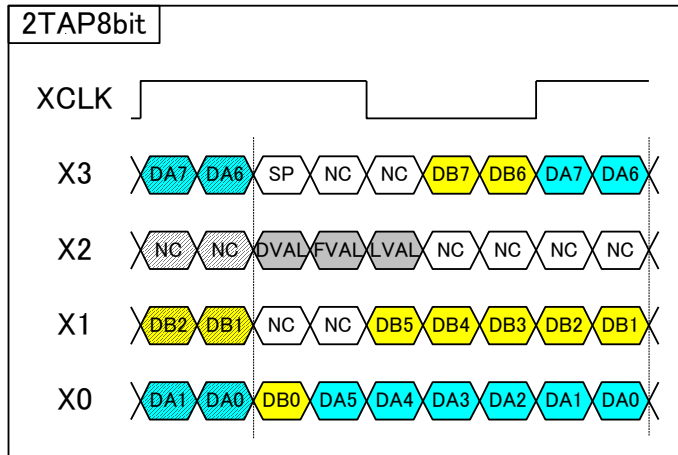

DA0 to DA7: 8 bit data for one pixel from TAP1.  
 DB0 to DB7: 8 bit data for one pixel from TAP2

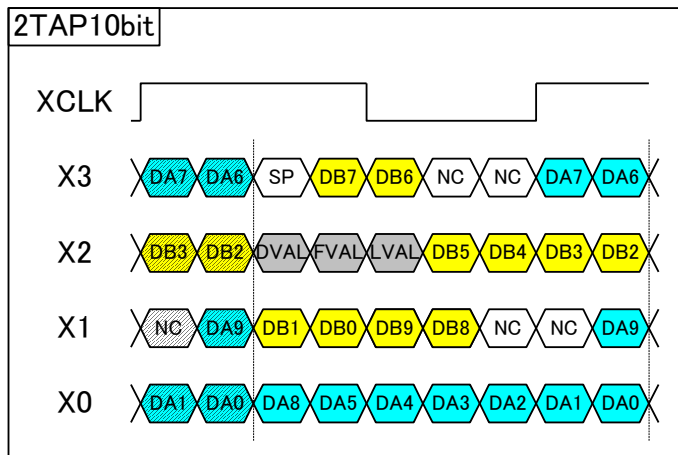

DA0 to DA9: 10 bit data for one pixel from TAP1  
 DB0 to DB9: 10 bit data for one pixel from TAP2

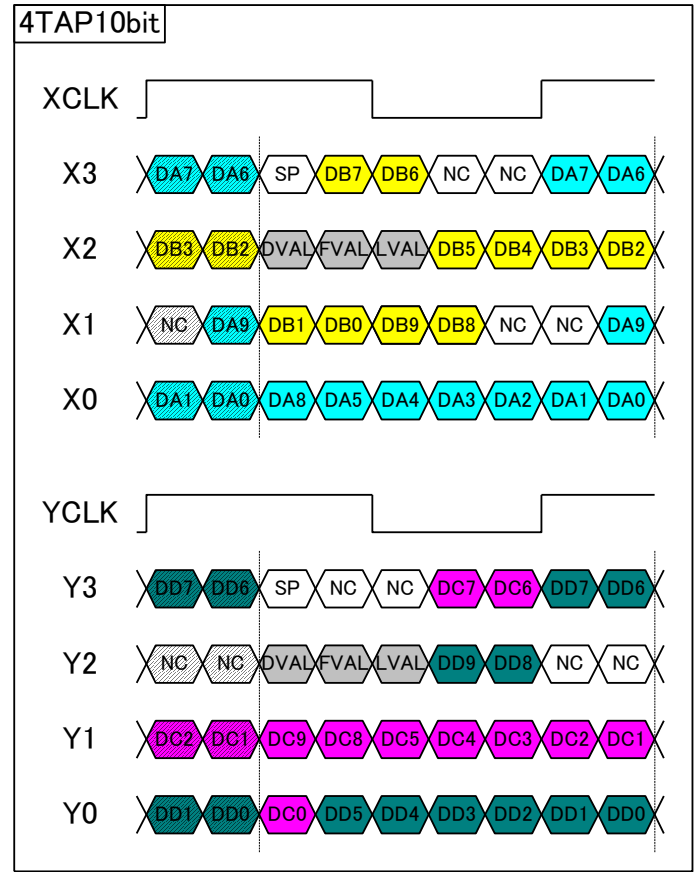
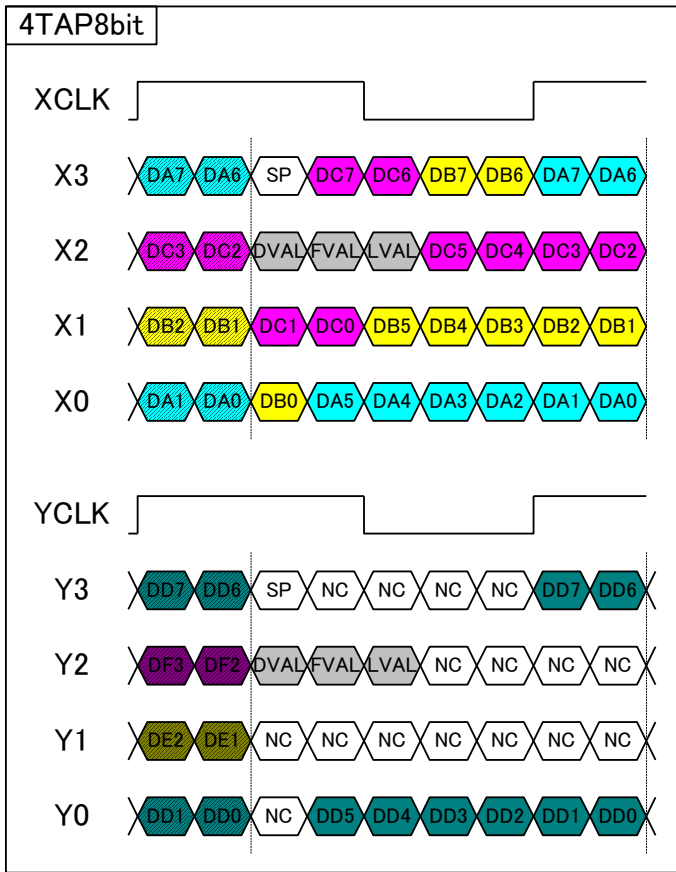

DA0 to DA7: 8 bit data for one pixel from TAP1  
 DB0 to DB7: 8bit data for one pixel from TAP2  
 DC0 to DC7: 8bit data for one pixel from TAP3  
 DD0 to DD7: 8bit data for one pixel from TAP4

DA0 to DA9:10bit data for one pixel from TAP1  
 DB0 to DB9:10bit data for one pixel from TAP2  
 DC0 to DC9:10bit data for one pixel from TAP3  
 DD0 to DD9:10bit data for one pixel from TAP4

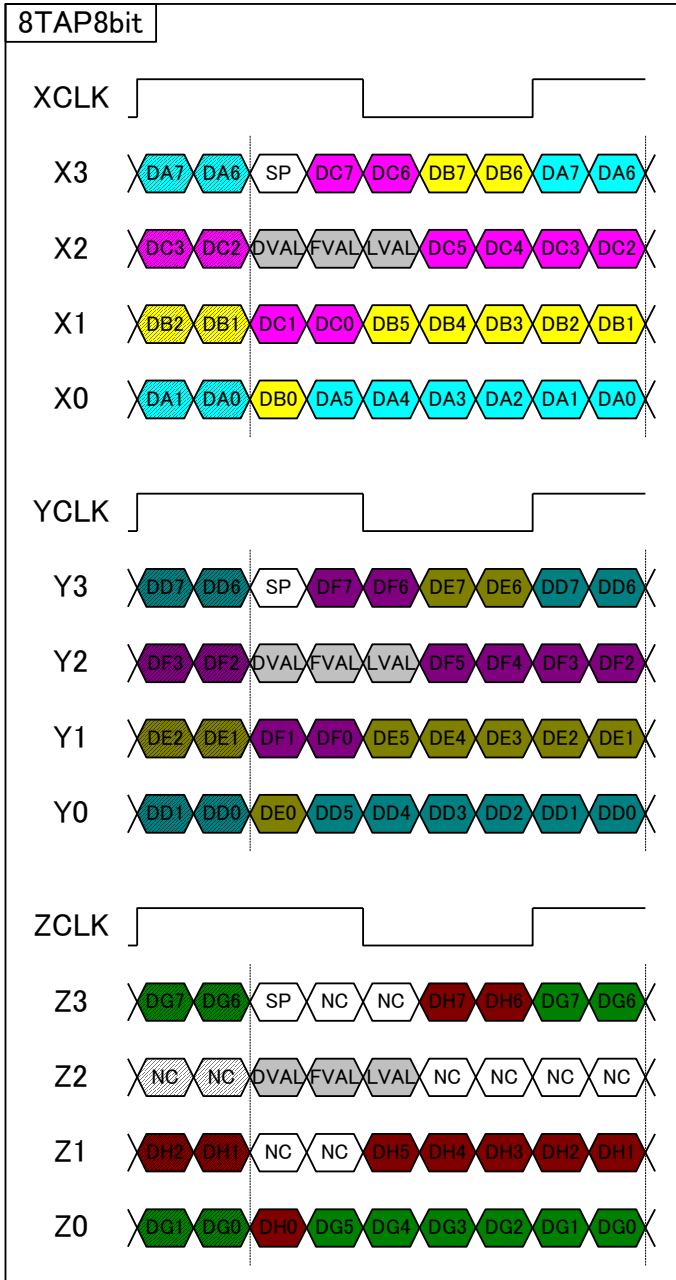

DA0 to DA7: 8 bit data for one pixel from TAP1  
 DB0 to DB7: 8 bit data for one pixel from TAP2  
 DC0 to DC7: 8 bit data for one pixel from TAP3  
 DD0 to DD7: 8 bit data for one pixel from TAP4  
 DE0 to DE7: 8 bit data for one pixel from TAP5  
 DF0 to DF7: 8 bit data for one pixel from TAP6  
 DG0 to DG7: 8 bit data for one pixel from TAP7  
 DH0 to DH7: 8 bit data for one pixel from TAP8

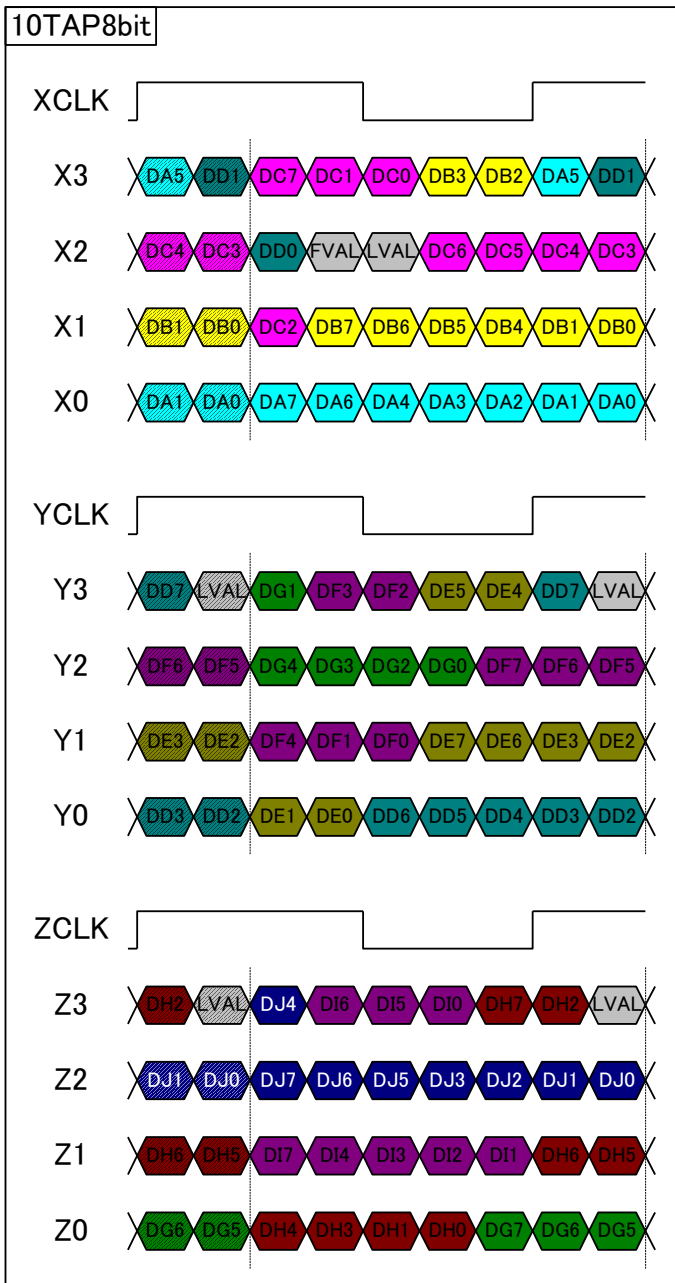

DA0 to DA7: 8 bit data for one pixel from TAP1  
 DB0 to DB7: 8 bit data for one pixel from TAP2  
 DC0 to DC7: 8 bit data for one pixel from TAP3  
 DD0 to DD7: 8 bit data for one pixel from TAP4  
 DE0 to DE7: 8 bit data for one pixel from TAP5  
 DF0 to DF7: 8 bit data for one pixel from TAP6  
 DG0 to DG7: 8 bit data for one pixel from TAP7  
 DH0 to DH7: 8 bit data for one pixel from TAP8  
 DI0 to DI7: 8 bit data for one pixel from TAP9  
 DJ0 to DJ7: 8 bit data for one pixel from TAP10



## E. Camera Link TAP Geometry

### 1. 2TAP (1X2-1Y)

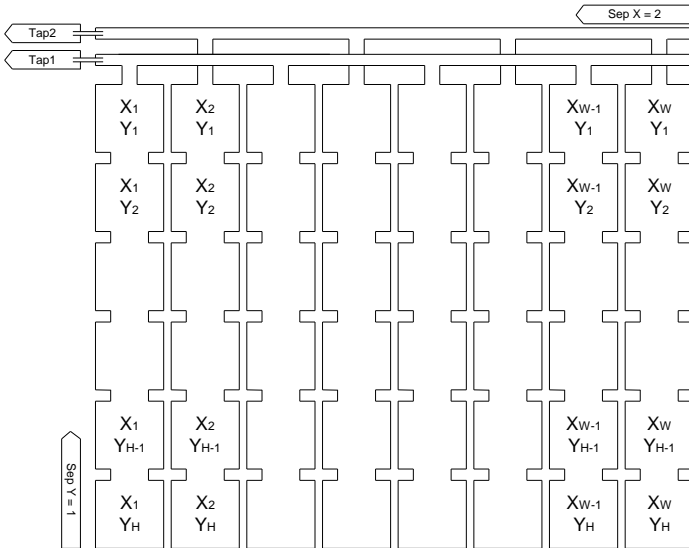

### 2. 4 TAP (1X4-1Y)

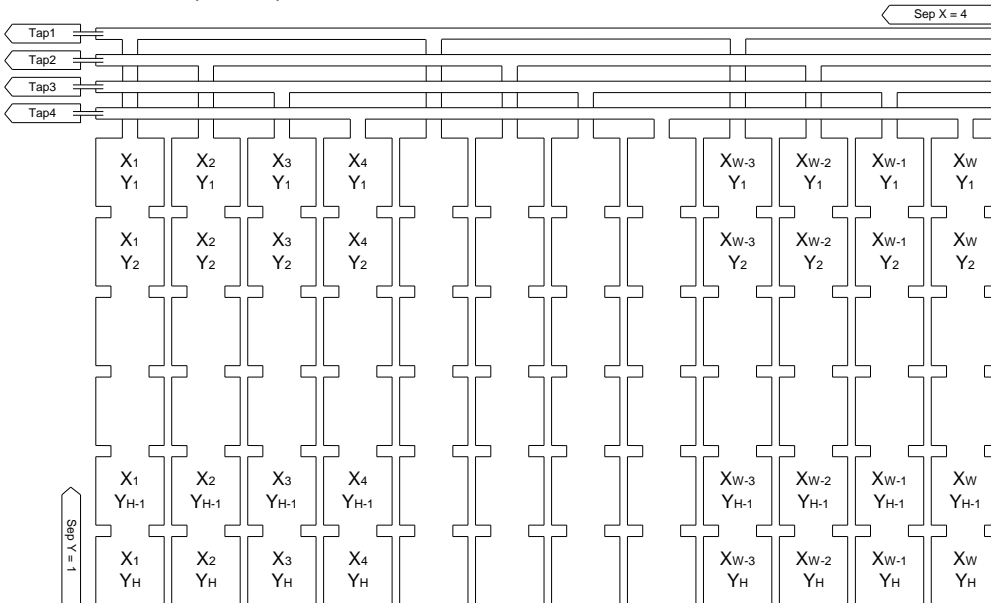

### 3. 8 TAP (1X8-1Y)

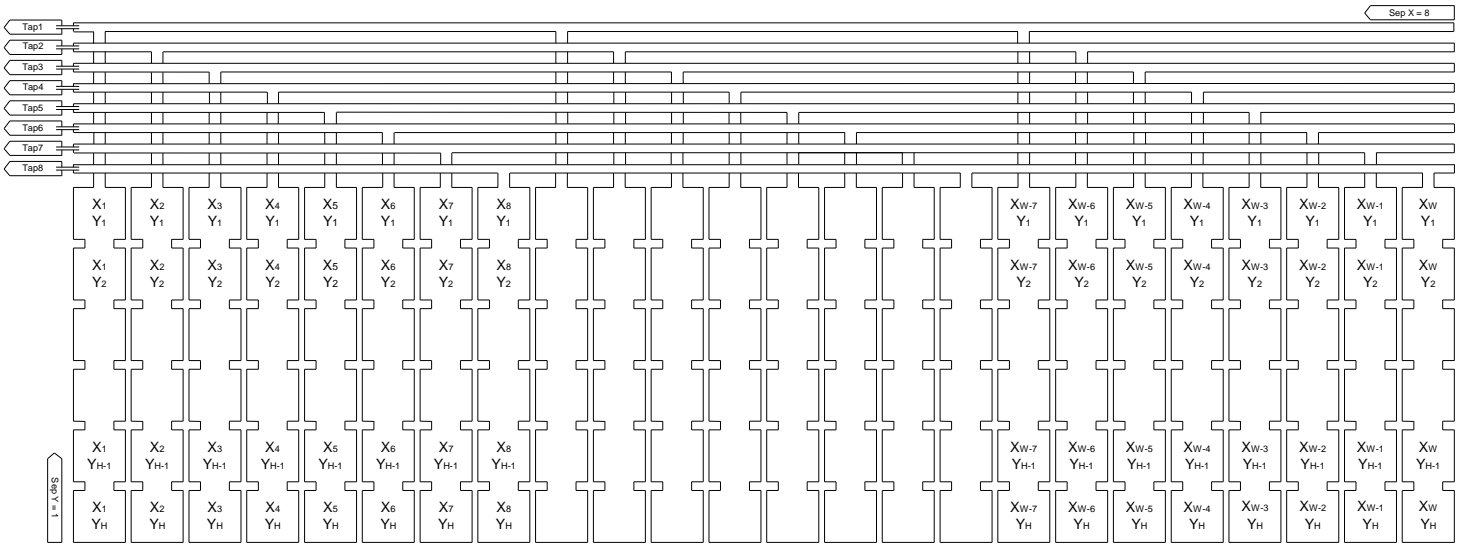

### 4. 10 TAP (1X10-1Y)

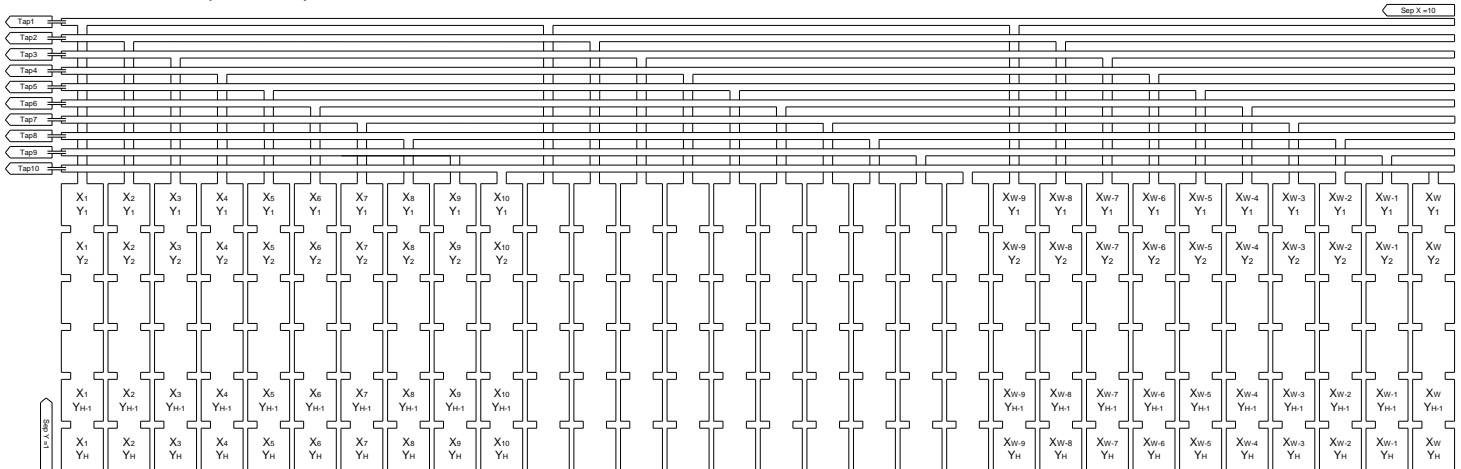

F. Bayer Pattern for Color Model (Only STC-CMC2MCL / STC-CMC4MCL)

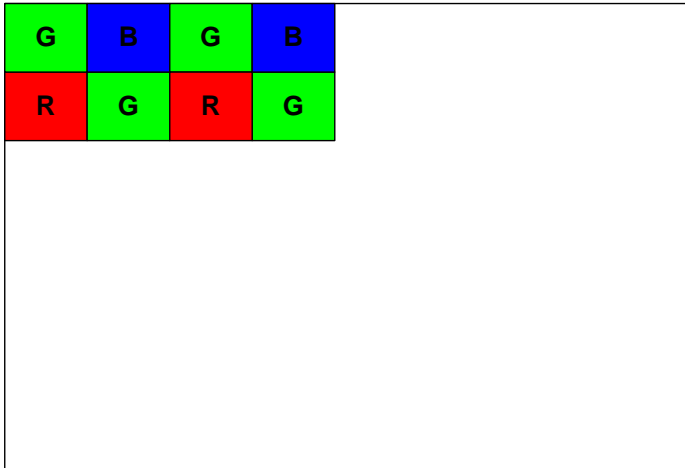

## V. Camera Function Modes

### A. Normal Mode

#### 1. Normal Mode (Electronic Shutter)

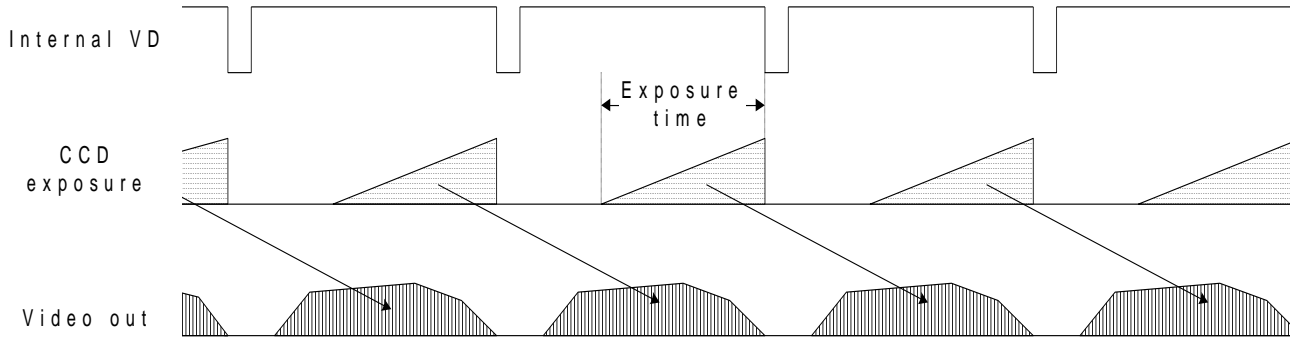

## B. Pulse Width Trigger Mode

In this trigger mode with positive polarity, the camera exposure starts at the rising edge of the trigger pulse and stops at the falling edge of the trigger pulse. Therefore, in the case of the exposure positive polarity is selected, the exposure periods are the high states of the trigger pulse.

### 1. Pulse Width Trigger Mode (V-Reset)

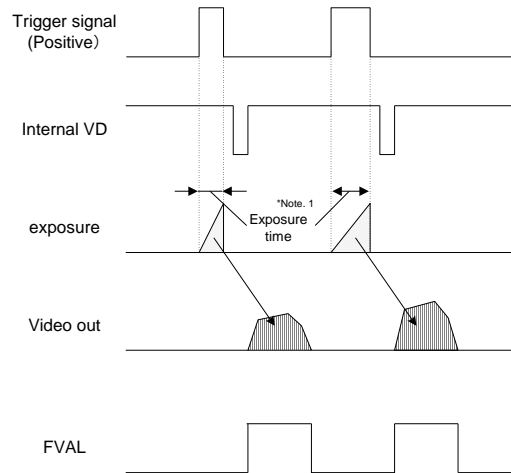

Note 1: The exposure time is set by the pulse width of the trigger signal.

## 2. Pulse Width Trigger Mode (Exposure Timing)

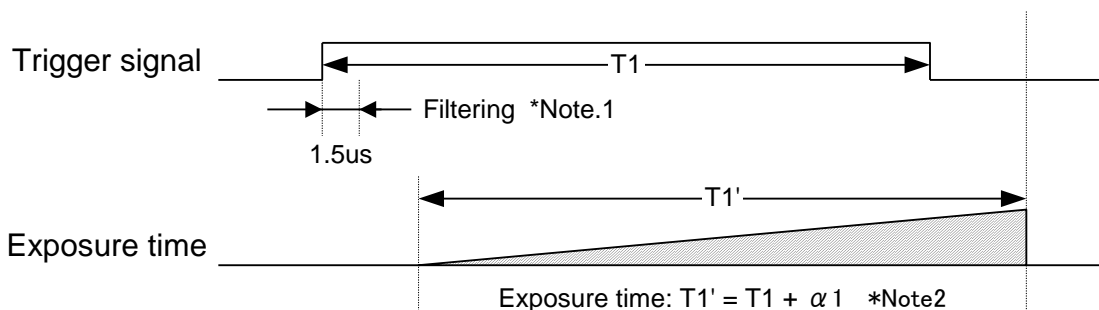

Note 1: The trigger signal is removed by the filtering if the pulse width of the input trigger signal is less than 15us. Please input the trigger signal that has more than 1.5 us pulse width.

Note 2:  $\alpha 1$  (Exposure time offset) is different from using clock, TAP number.

The formula of  $\alpha 1$  Exposure time offset (STC-CMB2MCL / CMC2MCL , STC-CMB4MCL / CMC4MCL)

$$\alpha 1 = 129 / \text{Sensor Output Pixel Clock} \times 20 \times 0.43$$

Mode (29H)	TAP Number	Scan	Configuration	CameraLink Output PixelClock Frequency 85MHz		CameraLink Output PixelClock Frequency 42.5MHz	
				Sensor Output Pixel Clock(MHz)	$\alpha 1$ (us)	Sensor Output Pixel Clock(MHz)	$\alpha 1$ (us)
0	2	Progressive	Base	10.625	104.4	5.3125	208.8
1	4	Progressive	Medium	21.250	52.2	10.625	104.4
2	8	Progressive	Full	42.500	26.1	21.250	52.2
3	10	Progressive		48.000	23.1	24.000	46.2
4							
5	2	Progressive	Base	21.250	52.2	10.625	104.4
6	2	Progressive	Base	42.500	26.1	21.250	52.2
7	4	Progressive	Medium	42.500	26.1	21.250	52.2
8	2	Binning	Base	21.250	52.2	10.625	104.4
9	4	Binning	Medium	42.500	26.1	21.250	52.2
10	2	Binning	Base	42.500	26.1	21.250	52.2
11	1	Binning	Base	42.500	26.1	21.250	52.2
12	2	Sub Sampling	Base	21.250	52.2	10.625	104.4
13	4	Sub Sampling	Medium	42.500	26.1	21.250	52.2
14	2	Sub Sampling	Base	42.500	26.1	21.250	52.2
15	1	Sub Sampling	Base	42.500	26.1	21.250	52.2

## C. Edge Preset Trigger Mode

In this trigger mode, the camera exposure starts at the rising edge of the trigger pulse. Exposure duration time is preset by the DIP Switch settings.

### 1. Edge Preset Trigger Mode (V-Reset)

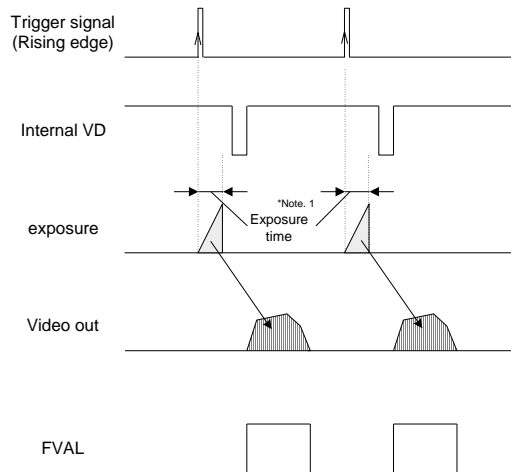

Note 1: The exposure time is set by the preset electronic shutter speed.

## 2. Edge Preset Trigger Mode (Exposure Timing)

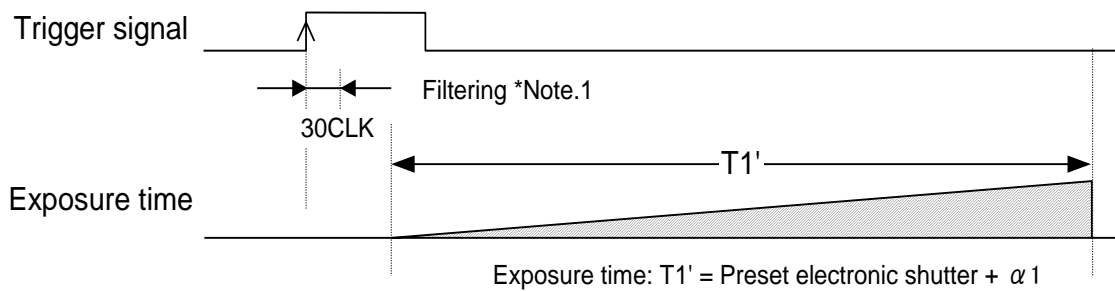

Note 1: The trigger signal is removed by the filtering if the pulse width of the input trigger signal is less than 15us.  
 Please input the trigger signal that has more than 1.5us pulse width.

Note 2:  $\alpha 1$ (Exposure time offset) is different from using clock, TAP number.

The formula of  $\alpha 1$  Exposure time offset (STC-CMB2MCL / CMC2MCL, STC-CMB4MCL / CMC4MCL)

$$\alpha 1 = 129 / \text{Sensor Output Pixel Clock} \times 20 \times 0.43$$

Mode (29H)	TAP Number	Scan	Configuration	CameraLink Output PixelClock Frequency 85MHz		CameraLink Output PixelClock Frequency 42.5MHz	
				Sensor Output Pixel Clock(MHz)	$\alpha 1$ (us)	Sensor Output Pixel Clock(MHz)	$\alpha 1$ (us)
0	2	Progressive	Base	10.625	104.4	5.3125	208.8
1	4	Progressive	Medium	21.250	52.2	10.625	104.4
2	8	Progressive	Full	42.500	26.1	21.250	52.2
3	10	Progressive		48.000	23.1	24.000	46.2
4							
5	2	Progressive	Base	21.250	52.2	10.625	104.4
6	2	Progressive	Base	42.500	26.1	21.250	52.2
7	4	Progressive	Medium	42.500	26.1	21.250	52.2
8	2	Binning	Base	21.250	52.2	10.625	104.4
9	4	Binning	Medium	42.500	26.1	21.250	52.2
10	2	Binning	Base	42.500	26.1	21.250	52.2
11	1	Binning	Base	42.500	26.1	21.250	52.2
12	2	Sub Sampling	Base	21.250	52.2	10.625	104.4
13	4	Sub Sampling	Medium	42.500	26.1	21.250	52.2
14	2	Sub Sampling	Base	42.500	26.1	21.250	52.2
15	1	Sub Sampling	Base	42.500	26.1	21.250	52.2



## VI. The Communication Protocol Specifications

This camera has the communication function that enables external devices like PC controls the camera functions. Please use "CICtrl" communication software or use following the communication protocol to communication to the camera.

### Note:

Communication problems may occur under the following conditions:

1. When the external sync frequency is illegal (more than 1% off from the specified frequency)
2. When external sync is unstable (Bad external sync signal)
3. For one second after switching from / to external sync mode or to / from internal sync mode.
4. For one second after switching the frame rate.

### A. The Communication Method

UART (RS232C), Binary Communication.

### B. The Communication Settings

	Settings
Baud rate	9,600bps / 38,400bps / 57,600bps / 115,200bps
Data bit	8bit
Parity	None
Stop bit	1bit
Flow control	None

### C. The Communication Format

1. The format for sending data from the PC to the camera is as follows:

a. Sending the Read Command

SOF (8bit)	Device code (6bit)	Read (1bit)	Page selection (1bit)	Command code (8bit)	Data length (8bit)	Data (1byte)	EOF (8bit)
---------------	-----------------------	----------------	--------------------------	------------------------	-----------------------	-----------------	---------------

b. Sending the Write Command

SOF (8bit)	Device code (6bit)	Write (1bit)	Page selection (1bit)	Command code (8bit)	Data length (8bit)	Data (Data length byte)	EOF (8bit)
---------------	-----------------------	-----------------	--------------------------	------------------------	-----------------------	----------------------------	---------------

2. The format for receiving data from the camera is as follows:

a. After the read command has been sent

SOF (8bit)	Data length (8bit)	Data (Data length byte)	EOF (8bit)
---------------	-----------------------	----------------------------	---------------

b. After the write command has been sent

SOF (8bit)	Data length (8bit) "00"	Receiving code (8bit)	EOF (8bit)
---------------	----------------------------	--------------------------	---------------

### 3. Descriptions of the Format

Name	Descriptions
SOF	<b>Start of the frame</b> Sets (or gets) the value is as "02H" always.
Device code	Sets the device code of the camera is as "000000".
Read / Write	Sets (or gets) "0" when send read command. Sets (or gets) "1" when send write command.
Page selection	Sets "0" when access to the command register of the camera Gets current data from the command register when sent read command. The data of the command register is replaced by the sent data when sent write command. <b>The data of the EEPROM is not replaced.</b>  Sets "1" when access to the EEPROM of the camera The camera works with the data of the EEPROM when the power on the camera. Gets the data from the EEPROM when sent read. The data of the EEPROM is replaced by sent data when sent write command. The camera sends the receiving coce as "01H" to the PC after the data of the EEPROM is replaced. The camera rejects other commands while the data of the EEPROM is being replaced (approximately 5 msec. / byte).
Command code	<b>Please refer from the following page.</b>
Data length	Data length (Unit: byte) Receiving data The data length is depending on the command after sent read command. The data length is "00H" after sent write command. Sending data The data length is 1 byte when send read command. The data length is depending on the command when send write command.
Data	The value of the data is depending on the command
EOF	<b>End of the frame</b> Sets (or gets) the value is as "03H" always
Receiving code	Result of the sending command

### 4. Example command

Send the read command to read the 00H address data of the register

02, 00, 00, 01, 00, 03

SOF, (Device code/Read/Register), Command code, Data length, Data, EOF

The return command

02, 01, 00, 03

## D. The Camera Control Commands

### 1. The Camera Commands List

Note1: The data unit of each command is 1byte (8bit).

Note2: The data can be saved to the “EEPROM” if an “x” is in the “Save to EEPROM” column in the list.

Note3: The camera is operating with the data of the EEPROM when the camera is powered on.

Command No.	Read / Write	Save to EEPROM	Function	Initial data	Data range
00 to 0FH			Reserved	-	-
10H	Read / Write	x	The camera function mode 1 (8bit: D[7..0])	0	
11H	Read / Write	x	The camera function mode 2 (8bit: D[7..0])	08H	
12H	Read / Write	x	The camera function mode 3 (8bit: D[7..0])	50H	
13H			Reserved	-	-
14H	Read / Write	x	The communication mode (8bit: D[7..0])	1	
15H	Read / Write	x	The start line of the variable partial scanning B (16bit: D[7..0])	CMB/CMC2MCL: 0	CMB/CMC2MCL: 0 to 1,087
16H	Read / Write	x	The start line of the variable partial scanning B (16bit: D[15..8])	CMB/CMC4MCL: 0	CMB/CMC4MCL: 0 to 2,047
17H	Read / Write	x	The effective lines of the variable partial scanning B (16bit: D[7..0])	CMB/CMC2MCL: 0	CMB/CMC2MCL: 0 to 1,088
18H	Read / Write	x	The effective lines of the variable partial scanning B (16bit: D[15..8])	CMB/CMC4MCL: 0	CMB/CMC4MCL: 0 to 2,048
19H	Read / Write	x	The start line of the variable partial scanning C (16bit: D[7..0])	CMB/CMC2MCL: 0	CMB/CMC2MCL: 0 to 1,087
1AH	Read / Write	x	The start line of the variable partial scanning C (16bit: D[15..8])	CMB/CMC4MCL: 0	CMB/CMC4MCL: 0 to 2,047
1BH	Read / Write	x	The effective lines of the variable partial scanning C (16bit: D[7..0])	CMB/CMC2MCL: 0	CMB/CMC2MCL: 0 to 1,088
1CH	Read / Write	x	The effective lines of the variable partial scanning C (16bit: D[15..8])	CMB/CMC4MCL: 0	CMB/CMC4MCL: 0 to 2,048
1D to 1FH			Reserved	-	-
20H	Read / Write	x	The exposure time of the electronic shutter (16bit: D[7..0])	CMB/CMC2MCL: 1088	0 to 16,777,215
21H	Read / Write	x	The exposure time of the electronic shutter (16bit: D[15..8])	CMB/CMC4MCL: 2048	
22H	Read / Write	x	The exposure time of the electronic shutter (16bit: D[23..16])		
23H			Reserved	-	-
24H	Read / Write	x	The start line of the variable partial scanning (16bit: D[7..0])	CMB/CMC2MCL: 0	CMB/CMC2MCL: 0 to 1,087
25H	Read / Write	x	The start line of the variable partial scanning (16bit: D[15..8])	CMB/CMC4MCL: 0	CMB/CMC4MCL: 0 to 2,047
26H	Read / Write	x	The effective lines of the variable partial scanning (16bit: D[7..0])	CMB/CMC2MCL: 1,088	CMB/CMC2MCL: 0 to 1,088
27H	Read / Write	x	The effective lines of the variable partial scanning (16bit: D[15..8])	CMB/CMC4MCL: 2,048	CMB/CMC4MCL: 0 to 2,048
28H	Read / Write	x	The delay time for the trigger (8bit: D[7..0])	0	0 to 255
29H	Read / Write	x	The camera function mode (8bit: D[7..0])	2	
2A - 2FH			Reserved	-	-
30H	Read / Write	x	ADC gain (8bit: D[7..0])	44	0 to 63
31H	Read / Write	x	The digital gain (8bit: D[7..0])	The factory adjusted value	-
32 to 37H			Reserved	-	-
38H	Read / Write	x	The clamp level (8bit: D[7..0])	40	0 to 255
39H			Reserved	-	-
3AH	Read / Write	x	R gain (8bit: D[7..0])	0	0 to 255
3BH	Read / Write	x	B gain (8bit: D[7..0])	0	0 to 255
3CH	Read / Write	x	Gr gain (8bit: D[7..0])	0	0 to 255
3DH	Read / Write	x	Gb gain (8bit: D[7..0])	0	0 to 255
3E to 3FH			Reserved	-	-
40H	Read / Write	x	The start line of the variable partial scanning D (16bit: D[7..0])	CMB/CMC2MCL: 0	CMB/CMC2MCL: 0 to 1,087
41H	Read / Write	x	The start line of the variable partial scanning D (16bit: D[15..8])	CMB/CMC4MCL: 0	CMB/CMC4MCL: 0 to 2,047
42H	Read / Write	x	The effective lines of the variable partial scanning D (16bit: D[7..0])	CMB/CMC2MCL: 0	CMB/CMC2MCL: 0 to 1,088
43H	Read / Write	x	The effective lines of the variable partial scanning D (16bit: D[15..8])	CMB/CMC4MCL: 0	CMB/CMC4MCL: 0 to 2,048
44 to 46H			Reserved	-	-
47H	Read / Write	x	HDR slope (8bit: D[7..0])	0	
48 to 4AH			Reserved	-	-
4BH	Read / Write	x	PGA (8bit: D[7..0])	96	

Command No.	Read / Write	Save to EEPROM	Function	Initial data	Data range
4CH	Read / Write	x	The horizontal start position of changeable DVAL (16bit: D[7..0])		
4DH	Read / Write	x	The horizontal start position of changeable DVAL (16bit: D[15..8])		
4EH	Read / Write	x	The horizontal effective pixels of changeable DVAL (16bit: D[7..0])		
4FH	Read / Write	x	The horizontal effective pixels of changeable DVAL (16bit: D[15..8])		
50H	Read / Write	x	The start line of the variable partial scanning E (16bit: D[7..0])	CMB/CMC2MCL: 0	CMB/CMC2MCL: 0 to 1,087
51H	Read / Write	x	The start line of the variable partial scanning E (16bit: D[15..8])	CMB/CMC4MCL: 0	CMB/CMC4MCL: 0 to 2,047
52H	Read / Write	x	The effective lines of the variable partial scanning E (16bit: D[7..0])	CMB/CMC2MCL: 0	CMB/CMC2MCL: 0 to 1,088
53H	Read / Write	x	The effective lines of the variable partial scanning E (16bit: D[15..8])	CMB/CMC4MCL: 0	CMB/CMC4MCL: 0 to 2,048
54 to 55H			Reserved	-	-
56H	Read / Write	x	Knee1 parameter (8bit: D[7..0])		
57H	Read / Write	x	Knee2 parameter (8bit: D[7..0])		
58 to 5AH			Reserved	-	-
5BH	Read / Write	x	Vlow2 voltage (8bit: D[7..0])	96	0 to 255
5C to 5EH			Reserved	-	-
5FH	Read / Write	x	Vlow3 voltage (8bit: D[7..0])	96	0 to 255
60 to 67H			Reserved	-	-
68H	Read / Write	x	Reverse mode (8bit: D[7..0])	0	
69 to 77H			Reserved	-	-
78H	Read / Write	x	Test pattern selection (8bit: D[7..0])	0	
79H	Read / Write	x	Image effect selection (8bit: D[7..0])	0	
7A to 8FH			Reserved	-	-
90H	Read / Write	x	The start line of the variable partial scanning F (16bit: D[7..0])	CMB/CMC2MCL: 0	CMB/CMC2MCL: 0 to 1,087
91H	Read / Write	x	The start line of the variable partial scanning F (16bit: D[15..8])	CMB/CMC4MCL: 0	CMB/CMC4MCL: 0 to 2,047
92H	Read / Write	x	The effective lines of the variable partial scanning F (16bit: D[7..0])	CMB/CMC2MCL: 0	CMB/CMC2MCL: 0 to 1,088
93H	Read / Write	x	The effective lines of the variable partial scanning F (16bit: D[15..8])	CMB/CMC4MCL: 0	CMB/CMC4MCL: 0 to 2,048
94H	Read / Write	x	The start line of the variable partial scanning G (16bit: D[7..0])	CMB/CMC2MCL: 0	CMB/CMC2MCL: 0 to 1,087
95H	Read / Write	x	The start line of the variable partial scanning G (16bit: D[15..8])	CMB/CMC4MCL: 0	CMB/CMC4MCL: 0 to 2,047
96H	Read / Write	x	The effective lines of the variable partial scanning G (16bit: D[7..0])	CMB/CMC2MCL: 0	CMB/CMC2MCL: 0 to 1,088
97H	Read / Write	x	The effective lines of the variable partial scanning G (16bit: D[15..8])	CMB/CMC4MCL: 0	CMB/CMC4MCL: 0 to 2,048
98H	Read / Write	x	The start line of the variable partial scanning H (16bit: D[7..0])	CMB/CMC2MCL: 0	CMB/CMC2MCL: 0 to 1,087
99H	Read / Write	x	The start line of the variable partial scanning H (16bit: D[15..8])	CMB/CMC4MCL: 0	CMB/CMC4MCL: 0 to 2,047
9AH	Read / Write	x	The effective lines of the variable partial scanning H (16bit: D[7..0])	CMB/CMC2MCL: 0	CMB/CMC2MCL: 0 to 1,088
9BH	Read / Write	x	The effective lines of the variable partial scanning H (16bit: D[15..8])	CMB/CMC4MCL: 0	CMB/CMC4MCL: 0 to 2,048
9C to D7H			Reserved	-	-
D8H	Read / Write	x	Pixel Defect	0	
D9H	Read / Write	x	LED control (8bit: D[7..0])	0	
DA to FFH			Reserved	-	-

2. Descriptions of the Camera Control Commands (The underlined settings are the factory default settings).

Command No.	Command descriptions								
10H: MOD1[7..0]	<p>[The camera function mode 1] Initial data: 0 Sets the camera function mode.</p> <p>D[7..0]</p> <p>D7: No function <u>Set always as "0"</u></p> <p>D6: Trigger polarity <u>0: Positive,</u> 1: Negative</p> <p>D5: Trigger mode <u>0: Edge preset,</u> 1: Pulse width</p> <p>D4: <b>Binning mode</b> <u>0: OFF (Normal),</u> 1: <b>ON (Binning)</b></p> <p>D3 to D0: No function <u>Sets always as "0000"</u></p>								
11H: MOD2[7..0]	<p>[The camera function mode 2] Initial data: 08H Sets the camera function mode.</p> <p>D[7..0]</p> <p>D7 : No function <u>Sets always as "0"</u></p> <p>D6 to D5: CameraLink Clock <u>00: 85MHz</u> 01: 42.5MHz 10: No function(Prohibited setting. Do not set these values) 11: No function(Prohibited setting. Do not set these values)</p> <p>D4: No function <u>Sets always as "0"</u></p> <p>D3: Function mode 0: Trigger mode, 1: <u>Continuous mode</u></p> <p>D2 to D0: Partial scanning <u>Sets always as "000"</u></p> <p>No video output without the trigger signal input while the camera works with the trigger mode.</p>								
12H: MOD3[7..0]	<p>[The camera function mode 3] Initial data: 40H Sets the camera function mode.</p> <p>D[7..0] <table border="1" style="display: inline-table; vertical-align: middle;"><tr><td>D7</td><td>D6</td><td>D5</td><td>D4</td><td>D3</td><td>D2</td><td>D1</td><td>D0</td></tr></table></p> <p>D7 to D6: Video out 00: 10bit, 01: <u>8bit,</u> 10: 12bit *Note 12H, 11: No function (Prohibited setting. Do not set these values)</p> <p>D5: Trigger signal input connector <u>0: Camera Link (CC1),</u> 1: Power/IO connector (No. 2 pin, SP4)</p> <p>D4: Exposure start mode 0: Normal, 1: Horizontal Synchronization</p> <p>D3 to D0: No function <u>Sets always as "000"</u></p>	D7	D6	D5	D4	D3	D2	D1	D0
D7	D6	D5	D4	D3	D2	D1	D0		
14H: UART[7..0]	<p>[The communication mode] Initial data: 1 Sets the communication mode.</p> <p>D[7..0]</p> <p>D7 to D2: No function <u>Sets always as "000000"</u></p> <p>D1 to D0: Communication mode 00: 38,400bps, 01: <u>9,600bps</u> 10: 57,600bps, 11: 115,200bps</p>								

Command No.	Command descriptions
15H: PSRB[7..0] 16H: PSRB[15..8]	<p>[The start line of the variable partial scanning B] STC-CMB2MCL/CMC2MCL: Initial data: PSRB[15..0] = 0, data range: 0 to 1,087 STC-CMB4MCL/CMC4MCL: Initial data: PSRB[15..0] = 0, data range: 0 to 2,047</p> <p>Sets the start line of the variable partial scanning B.</p> <p>Actual start line of the partial scanning B = this value + 1</p>
17H: PWRB[7..0] 18H: PWRB[15..8]	<p>[The effective lines of the variable partial scanning B] STC-CMB2MCL/CMC2MCL: Initial data: PWRB[15..0] = 0, data range: 0 to 1,088 STC-CMB4MCL/CMC4MCL: Initial data: PWRB[15..0] = 0, data range: 0 to 2,048</p> <p>Sets the number of the effective lines (image height) of the variable partial scanning B.</p> <p>The camera works with full scanning when the total effective lines of the eight partial (PWR[] + PWRB[] + PWRC[] + PWRD[] + PWRE[] + PWRF[] + PWRG[] + PWRH[]) is greater than below value: STC-CMB2MCL/CMC2MCL: 1,088 STC-CMB4MCL/CMC4MCL: 2,048</p>
19H: PSRC[7..0] 1AH: PSRC[15..8]	<p>[The start line of the variable partial scanning C] STC-CMB2MCL/CMC2MCL: Initial data: PSRC[15..0] = 0, data range: 0 to 1,087 STC-CMB4MCL/CMC4MCL: Initial data: PSRC[15..0] = 0, data range: 0 to 2,047</p> <p>Sets the start line of the variable partial scanning C.</p> <p>Actual start line of the partial scanning C = this value + 1</p>
1BH: PWRC[7..0] 1CH: PWRC[15..8]	<p>[The effective lines of the variable partial scanning C] STC-CMB2MCL/CMC2MCL: Initial data: PWRC[15..0] = 0, data range: 0 to 1,088 STC-CMB4MCL/CMC4MCL: Initial data: PWRC[15..0] = 0, data range: 0 to 2,048</p> <p>Sets the number of the effective lines (image height) of the variable partial scanning C.</p> <p>The camera works with full scanning when the total effective lines of the eight partial (PWR[] + PWRB[] + PWRC[] + PWRD[] + PWRE[] + PWRF[] + PWRG[] + PWRH[]) is greater than below value: STC-CMB2MCL/CMC2MCL: 1,088 STC-CMB4MCL/CMC4MCL: 2,048</p>

Command No.	Command descriptions
20H: SVR[7..0] 21H: SVR[15..8] 22H: SVR[23..16]	<p>[The exposure time of the electronic shutter] Initial data: SVR[23..0] = 0, data range: 0 to 16,777,215</p> <p>Sets the preset shutter speed for electronic shutter.</p> <p>Exposure time (shutter speed) = SVR[23..0] x (129 pixels) x (1CLK cycle)</p> <p>STC-CMB2MCL/CMC2MCL When set 0 for SVR[23..0], the camera works with 1,088 line exposure.</p> <p>STC-CMB4MCL/CMC4MCL When set 0 for SVR[23..0], the camera works with 2,048 line exposure.</p>
24H: PSR[7..0] 25H: PSR[15..8]	<p>[The start line of the variable partial scanning] STC-CMB2MCL/CMC2MCL: Initial data: PSR[15..0] = 0, data range: 0 to 1,087 STC-CMB4MCL/CMC4MCL: Initial data: PSR[15..0] = 0, data range: 0 to 2,047</p> <p>Sets the start line of the variable partial scanning.</p> <p>Actual start line of the partial scanning = this value + 1</p>
26H: PWR[7..0] 27H: PWR[15..8]	<p>[The effective lines of the variable partial scanning] STC-CMB2MCL/CMC2MCL: Initial data: PWR[15..0] = 1,088, data range: 0 to 1,088 STC-CMB4MCL/CMC4MCL: Initial data: PWR[15..0] = 2,048, data range: 0 to 2,048</p> <p>Sets the number of the effective lines (image height) of the variable partial scanning.</p> <p>The camera works with full scanning when the total effective lines of the eight partial (PWR[] + PWRB[] + PWRC[] + PWRD[] + PWRE[] + PWRF[] + PWRG[] + PWRH[]) is grater than below value: STC-CMB2MCL/CMC2MCL: 1,088 STC-CMB4MCL/CMC4MCL: 2,048</p>
28H: DLY[7..0]	<p>[The delay time for the trigger] Initial data: DLY[7..0] = 0, data range: 0 to 255</p> <p>Sets the delay time that is from the trigger signal input to start exposure.</p> <p>Delay time = 2 x DLY[7..0] (usecond)</p>

Command No.	Command descriptions
29H: MOD6[7..0]	<p>[The camera function mode] Initial data: 2 Sets the camera function mode.</p> <p>D[7..0]</p> <p>D7 to D4: Horizontal AOI      128 pixel shifts to the left when increase one for this. <u>(Default: 0000)</u></p> <p>D3 to D0: Output taps and frame rate (STC-CMB2MCL/CMC2MCL/STC-CMB4MCL/CMC4MCL)</p> <ul style="list-style-type: none"> <li>0 : 2TAP (85.0MHz, Horizontal: 2,048 pixels),</li> <li>1 : 4TAP (85.0MHz, Horizontal: 2,048 pixels),</li> <li>2 : <u>8TAP (85.0MHz, Horizontal: 2,048 pixels),</u></li> <li>3 : 10TAP (80.0MHz, Horizontal: 2,048 pixels),</li> <li>4 : Reserved</li> <li>5 : 2TAP (85.0MHz, Horizontal: 1,024 pixels),</li> <li>6 : 2TAP (85.0MHz, Horizontal: 512 pixels),</li> <li>7 : 4TAP (85.0MHz, Horizontal: 1,024 pixels)</li> <li>8 : 2TAP (85.0MHz, 2x2 Binning),</li> <li>9 : 4TAP (85.0MHz, 2x2 Binning),</li> <li>10 : 2TAP (85.0MHz, 4x4 Binning),</li> <li>11 : 1TAP (85.0MHz, 8x8 Binning),</li> <li>12 : 2TAP (85.0MHz, 2x2 Subsampling),</li> <li>13 : 4TAP (85.0MHz, 2x2 Subsampling),</li> <li>14 : 2TAP (85.0MHz, 4x4 Subsampling),</li> <li>15 : 1TAP (85.0MHz, 8x8 Subsampling),</li> </ul>
30H: ADC_gain [7..0]	<p>[ADC gain] Initial data: AGC_gain[7..0] = 44, data range:0 to 63 Sets the ADC gain (programable gain).</p> <p>The proper value is different each pixel clock. The value for each pixel clock is stored the below address. The proper value loads to ADC_gain when the power on the camera or change the clock speed.</p> <ul style="list-style-type: none"> <li>E6H:      ADC_gain for 10.625 MHz pixel clock</li> <li>E7H:      ADC_gain for 21.250 MHz pixel clock</li> <li>E8H:      ADC_gain for 42.500 MHz pixel clock</li> <li>E9H:      ADC_gain for 48.000 MHz pixel clock</li> <li>EDH:      ADC_gain for 5.3125 MHz pixel clock</li> <li>EFH:      ADC_gain for 24.000 MHz pixel clock</li> </ul>
31H: DGB[7..0]	<p>[The digital gain] Initial data: DGB[7..0] = The factory adjusted value (The value of the address 0EH)</p> <p>Video level = (Input video level - CLAMP[7..0]) x (1 + DGB[7..0] / 128) + CLAMP[7..0]</p> <p>CLAMP[7..0]: The clamp level (The value of the address 38H)</p>
38H:	<p>[The clamp level] Initial data: CLAMP[7..0] = 40, data range: 0 to 255</p>









Command No.	Command descriptions			
78H: TESTP[7..0]	<p>[Test pattern selection] Initial data: TESTP[7..0] = 00H            Sets the test pattern output form the camera.</p> <p>D[7..0]</p> <table border="0" style="width: 100%;"> <tr> <td style="width: 50%; vertical-align: top;">           00H: Video output,            02H: Ramp wave,            04H: White clip,            Others: Black         </td> <td style="width: 50%; vertical-align: top;">           01H: Gray schale,            03H: 100% White,            05H: Color bar (RGB bayer),         </td> </tr> </table>	00H: Video output, 02H: Ramp wave, 04H: White clip, Others: Black	01H: Gray schale, 03H: 100% White, 05H: Color bar (RGB bayer),	
00H: Video output, 02H: Ramp wave, 04H: White clip, Others: Black	01H: Gray schale, 03H: 100% White, 05H: Color bar (RGB bayer),			
79H: EFFCT[7..0]	<p>[Image effect selection] Initial data: EFFCT[7..0] = 00H            Sets the imgae effect.</p> <p>D[7..0]</p> <p>D7:            Negative video / Positive video selection</p> <table border="0" style="width: 100%;"> <tr> <td style="width: 33%;"></td> <td style="width: 33%; vertical-align: top;"> <u>0: Positive image,</u>            00H: <u>No effect (Original),</u>            02H: 8bit gradation,            04H: 6bit gradation,            06H: 4bit gradation,            08H: 2bit gradation,            0A to 7FH: No function            (Prohibited setting. Do not set these values)         </td> <td style="width: 33%; vertical-align: top;">           1: Negative image            01H: 9bit gradation,            03H: 7bit gradation,            05H: 5bit gradation,            07H: 3bit gradation,            09H: 1bit gradation,         </td> </tr> </table> <p>D6 to D0: Image effect</p>		<u>0: Positive image,</u> 00H: <u>No effect (Original),</u> 02H: 8bit gradation, 04H: 6bit gradation, 06H: 4bit gradation, 08H: 2bit gradation, 0A to 7FH: No function (Prohibited setting. Do not set these values)	1: Negative image 01H: 9bit gradation, 03H: 7bit gradation, 05H: 5bit gradation, 07H: 3bit gradation, 09H: 1bit gradation,
	<u>0: Positive image,</u> 00H: <u>No effect (Original),</u> 02H: 8bit gradation, 04H: 6bit gradation, 06H: 4bit gradation, 08H: 2bit gradation, 0A to 7FH: No function (Prohibited setting. Do not set these values)	1: Negative image 01H: 9bit gradation, 03H: 7bit gradation, 05H: 5bit gradation, 07H: 3bit gradation, 09H: 1bit gradation,		

Command No.	Command descriptions
90H: PSRF[7..0] 91H: PSRF[15..8]	<p>[The start line of the variable partial scanning F] STC-CMB2MCL/CMC2MCL: Initial data: PSRF[15..0] = 0, data range: 0 to 1,087 STC-CMB4MCL/CMC4MCL: Initial data: PSRF[15..0] = 0, data range: 0 to 2,047</p> <p>Sets the start line of the variable partial scanning F.</p> <p>Actual start line of the partial scanning F = this value + 1</p>
92H: PWRP[7..0] 93H: PWRP[15..8]	<p>[The effective lines of the variable partial scanning F] STC-CMB2MCL/CMC2MCL: Initial data: PWRP[15..0] = 0, data range: 0 to 1,088 STC-CMB4MCL/CMC4MCL: Initial data: PWRP[15..0] = 0, data range: 0 to 2,048</p> <p>Sets the number of the effective lines (image height) of the variable partial scanning F.</p> <p>The camera works with full scanning when the total effective lines of the eight partial (PWR[] + PWRB[] + PWRC[] + PWRD[] + PWRE[] + PWRF[] + PWRG[] + PWRH[]) is greater than below value: STC-CMB2MCL/CMC2MCL: 1,088 STC-CMB4MCL/CMC4MCL: 2,048</p>
94H: PSRG[7..0] 95H: PSRG[15..8]	<p>[The start line of the variable partial scanning G] STC-CMB2MCL/CMC2MCL: Initial data: PSRG[15..0] = 0, data range: 0 to 1,087 STC-CMB4MCL/CMC4MCL: Initial data: PSRG[15..0] = 0, data range: 0 to 2,047</p> <p>Sets the start line of the variable partial scanning G.</p> <p>Actual start line of the partial scanning G = this value + 1</p>
96H: PWRG[7..0] 97H: PWRG[15..8]	<p>[The effective lines of the variable partial scanning G] STC-CMB2MCL/CMC2MCL: Initial data: PWRG[15..0] = 0, data range: 0 to 1,088 STC-CMB4MCL/CMC4MCL: Initial data: PWRG[15..0] = 0, data range: 0 to 2,048</p> <p>Sets the number of the effective lines (image height) of the variable partial scanning G.</p> <p>The camera works with full scanning when the total effective lines of the eight partial (PWR[] + PWRB[] + PWRC[] + PWRD[] + PWRE[] + PWRF[] + PWRG[] + PWRH[]) is greater than below value: STC-CMB2MCL/CMC2MCL: 1,088 STC-CMB4MCL/CMC4MCL: 2,048</p>

Command No.	Command descriptions				
98H: PSRH[7..0] 99H: PSRH[15..8]	<p>[The start line of the variable partial scanning H] STC-CMB2MCL/CMC2MCL: Initial data: PSRH[15..0] = 0, data range: 0 to 1,087 STC-CMB4MCL/CMC4MCL: Initial data: PSRH[15..0] = 0, data range: 0 to 2,047</p> <p>Sets the start line of the variable partial scanning H.</p> <p>Actual start line of the partial scanning H = this value + 1</p>				
9AH: PWRH[7..0] 9BH: PWRH[15..8]	<p>[The effective lines of the variable partial scanning H] STC-CMB2MCL/CMC2MCL: Initial data: PWRH[15..0] = 0, data range: 0 to 1,088 STC-CMB4MCL/CMC4MCL: Initial data: PWRH[15..0] = 0, data range: 0 to 2,048</p> <p>Sets the number of the effective lines (image height) of the variable partial scanning H.</p> <p>The camera works with full scanning when the total effective lines of the eight partial (PWR[] + PWRB[] + PWRC[] + PWRD[] + PWRE[] + PWRF[] + PWRG[] + PWRH[]) is grater than below value: STC-CMB2MCL/CMC2MCL: 1,088 STC-CMB4MCL/CMC4MCL: 2,048</p>				
D9H: [7..0]	<p>[LED control] Initial data: [7..0] = 0 Sets the LED control method.</p> <p>D[7..0]</p> <table border="0"> <tr> <td>D7 to D1: No function</td> <td><u>Sets always as "0000000"</u></td> </tr> <tr> <td>D0: LED control</td> <td><u>0: LED control by the function mode,</u> When continuous mode: LED On When trigger mode: LED On 1 second then Off 1 second (repeatedly) 1: LED Off</td> </tr> </table>	D7 to D1: No function	<u>Sets always as "0000000"</u>	D0: LED control	<u>0: LED control by the function mode,</u> When continuous mode: LED On When trigger mode: LED On 1 second then Off 1 second (repeatedly) 1: LED Off
D7 to D1: No function	<u>Sets always as "0000000"</u>				
D0: LED control	<u>0: LED control by the function mode,</u> When continuous mode: LED On When trigger mode: LED On 1 second then Off 1 second (repeatedly) 1: LED Off				

### 3. The Sequence for Saving Commands to the EEPROM

Please use the sequence below in order to save commands to the EEPROM.

- 1) Set "1" to the 80H.0 for the accept "write control to the EEPROM".
- 2) Send the command and the save data with the EEPROM access command, which is set "1" for the page selection.
- 3) The camera send back the one of the below receiving code after write EEPROM.  
01H: OK  
10H: EEPROM write error
- 4) 80H.0 is changed to "0" automatically after write EEPROM.

Note.1) DO NOT save to the EEPROM when 80H.0 is "0".

Note.2) When save the multiple sequence command to the EEPROM, all data save to the EEPROM by one operation from 1) to 4).

Example of the multiple sequence command: "10H, 11H, 12H and 13H" or "22H, 23H and 24H".

Note.3) When save the multiple command data, which is not sequence command, to the EEPROM, it is necessary to operate the number of times from 1) to 4).

Example of the multiple command: "10H, 13H, 19H and 1BH" or "20H, 23H and 25H".

## VII. Control Software

### A. Summary

After installing the control software, and launching “CLCtrl2.exe”, the main window appears as below.

**Menu**  
As for the detail, please refer to the next page.

**Camera Setting Parameters**  
As for the detail, please refer to the next chapter [Error!](#)  
[Reference source not found..](#)

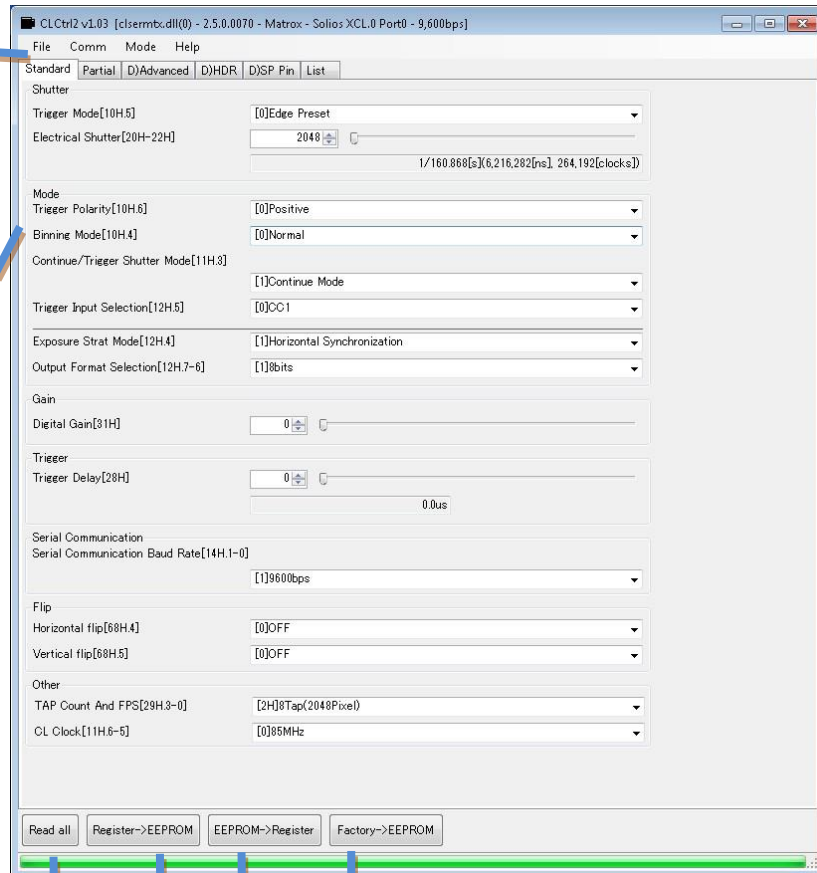

Load the factory saved settings data to EEPROM .  
As for the detail, please refer to the next chapter [Error!](#)  
[Reference source not found..](#)

Load the previously saved settings data from EEPROM to Register.  
As for the detail, please refer to the next chapter [Error!](#) [Reference source not found..](#)

Save the camera setting data on the register to EEPROM.  
As for the detail, please refer to the next chapter [Error!](#)  
[Reference source not found..](#)

Read the camera setting data from Register.  
As for the detail, please refer to the next chapter [Error!](#) [Reference source not found](#)



## 1. File

Open [From File to Register]

Open the camera setting file (.i2c).

Save as[From Register to File]

Save the current camera setting data on the register to the PC as i2c file.

Open[From File to EEPROM]

Open the camera setting file (.i2c) that is read at power on.

Save as[From EEPROM to File]

Save the camera setting data on EEPROM to the PC as i2c file.

Quit

Exit the control software.

## 2. Comm

### Port Setting

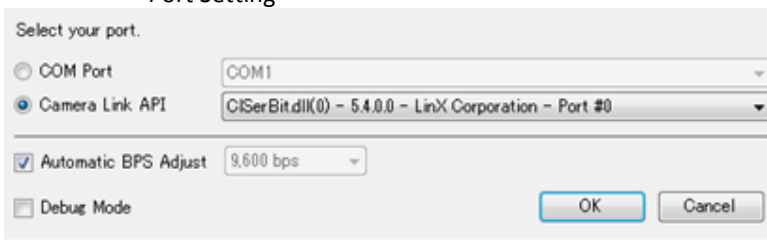

[Select your port]

COM port When the Graber Board supports COM port, Please select this command.

Camera Link API When the Graber Board supports Camera Link API, Please select this command.

[Automatic BPS Adjust]

Select the serial communication speed automatically. When un-checked the box, communication speed can be selected.

[Debug Mode]

Basically un-checked the box, when checked the box, transfer data can be monitored through 3rd party software.

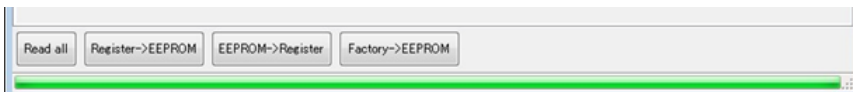

Read All

Read the setting of all data from the camera register. This setting data on the register cannot be saved without saving the EEPROM (Register → EEPROM)

Register → EEPROM

Save the register data into the EEPROM on the camera. When the camera turns off, the data remains on the EEPROM.

EEPROM → Register

Read the EEPROM data into the register. When saved data needs to be used again, this can be done.

Factory → EEPROM

Restore the Factory setting data from EEPROM to the register.

### 3. Mode

#### Language

Select the language from English or Japanese.

### 4. Help

#### Advanced Operation

When password (sentechcamera) is input, additional functions appear for power user. SP Pin tab can be used.

#### Version Information

Software information window appear.

## B. Software Function (Standard)

This tab has basic camera function, the number (like [10H.5]) beside of the function is register address. When direct register access is needed, please refer to Section VI: The Communication Protocol Specifications.

### 1. Shutter

Shutter

Trigger Mode[10H.5] [0]Edge Preset

Electrical Shutter[20H-22H] 2048

1/160.868[s](6,216,282[ns], 264,192[clocks])

#### Trigger Mode

**Edge Preset** The camera exposure starts at the rising (or falling) edge of the trigger pulse.

Exposure duration time is preset.

**Pulse Width** The camera exposure starts at the rising (or falling) edge of the trigger pulse and stops at the falling (or rising) edge of the trigger pulse.

As for the detail of Trigger Mode, please refer to Section V: Camera Function Modes.

#### Electrical Shutter

Electrical shutter setting can be set through the slide bar or set through the actual register value. Actual exposure time appears on the bottom of the slide bar.

As for the detail of the exposure time setting, please refer to Section VI: The Communication Protocol Specifications.

## 2. Mode

Mode	
Trigger Polarity[10H.6]	[0]Positive
Binning Mode[10H.4]	[0]Normal
Continue/Trigger Shutter Mode[11H.3]	[1]Continue Mode
Trigger Input Selection[12H.5]	[0]CC1
Exposure Strat Mode[12H.4]	[1]Horizontal Synchronization
Output Format Selection[12H.7-6]	[1]8bits

Positive      Positive Signal is available as Trigger  
 Negative      Negative Signal is available as Trigger

### Binning Mode

Normal      Disable the binning.  
 Binning      Enable the binning.

### Continue / Trigger Shutter Mode

Continue Mode      Obtaining the image from the camera automatically. The trigger is generated inside of the camera continuously.  
 Trigger Shutter Mode      Obtaining the image from the external trigger timing. When this mode is selected Edge Preset, Pulse Width on the [Trigger Mode] are available.

As for the details of the Continue Mode, Trigger Shutter Mode, please refer to Section V: Camera Function Modes

### Trigger Input Selection

CC1:      Trigger Signal input from camera link connector on pin CC1.  
 SP4:      Trigger Signal input from I/O port. As for the details on this port, please refer to Section VII-A: Using the Trigger Signal through 6pin.

### Exposure Start Mode

Normal      Exposure is going to start after trigger input. The exposure can start during the video out from the camera with horizontal noises.  
 Horizontal Synchronization      The exposure can start during the video out from the camera without horizontal noises. The maximum delay to start exposure from the trigger input in 1H.  
 Output Format Selection      Video output bit can be selected 8/10/12 bit. Video output bit is different for each mode. As for the relation of each more to video output, please refer to Section IV-B: The Vertical Timings.

### 3. Gain

Gain

Digital Gain[31H]

#### Digital Gain

The value of digital gain. As for the details of gain calculation, please refer to the command: 31H.

### Trigger

Trigger

Trigger Delay[28H]

#### Trigger Delay

The delay time for the trigger. As for the details of delay time calculation, please refer to the command: 28H.

### 4. Serial Communication

Serial Communication

Serial Communication Baud Rate[14H.1-0]

#### Serial Communication Baud Rate

Baud rate can be selected.

### 5. Flip

Flip

Horizontal flip[68H.4]

Vertical flip[68H.5]

#### Horizontal Flip

- OFF Normal Image
- ON Horizontal Mirror Image

#### Vertical Flip

- OFF Normal Image
- ON Vertical Mirror Image

## 6. Other

Other	
TAP Count And FPS[29H.3-0]	[2H]8Tap(2048Pixel) ▼
CL Clock[11H.6-5]	[0]85MHz ▼

### TAP Count and FPS

TAP number can be selected by frame rate, Camera Link Output Bit, Video mode. As for the details, please refer to Section IV-B: Vertical Timing

### CL Clock

Camera Link Output Pixel Clock Frequency (MHz) supports High Speed mode and Low Speed mode. Clock speed can be selected by the frame rate, Camera Link Output, and video mode. As for the details, please refer to section IV-B: Vertical Timing.

## C. Software Function (Partial)

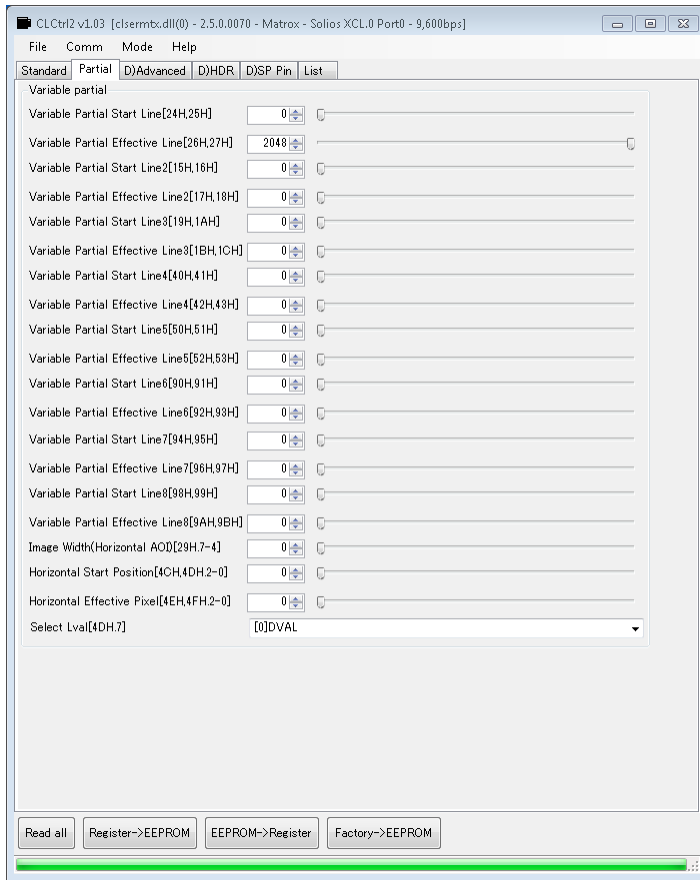

### Variable Partial

Partial Scan can be set. As for the details, please refer to Section VII: The Communication Protocol Specifications

## D. Software Function (Advanced)

This tab is used for factory setting, please DO NOT use this tab.

## E. Software Function (HDR)

This tab is used for the power user to control the Gamma deeply. Do not use the color model.

## F. Software Function (SP Pin)

External trigger can be used. As for the detail, please refer to Section VIII-A: Using the Trigger Signal through 6pin

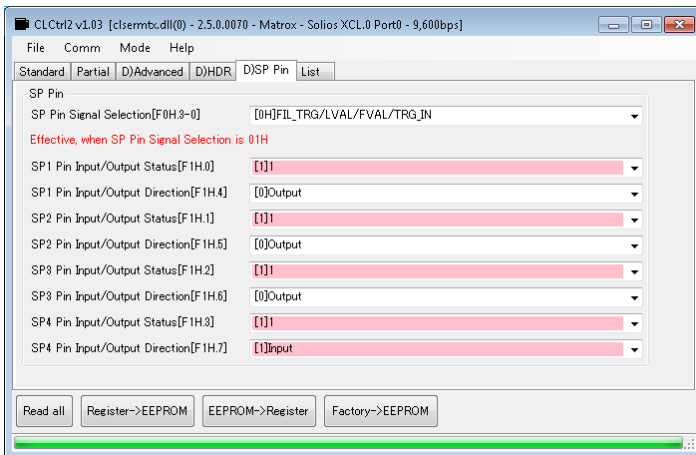

## VIII. Actual Camera Setting & Technical Notes

### A. Using the Trigger Signal Through 6pin

- 1) Select the "[0]Trigger Shutter Mode (Long Exposure)" on Continue / Trigger Shutter Mode Selection at the Standard tab through the control software. (CLCtrl2)
- 2) Select the "[0H] FIL\_TRG/LVAL/FVAL\_TRG\_IN" on SP\_Pin Signal Selection at SP\_Pin Tab.
- 3) Input the trigger signal through Pin2. As for using the software, please refer to Section VI: Control Software

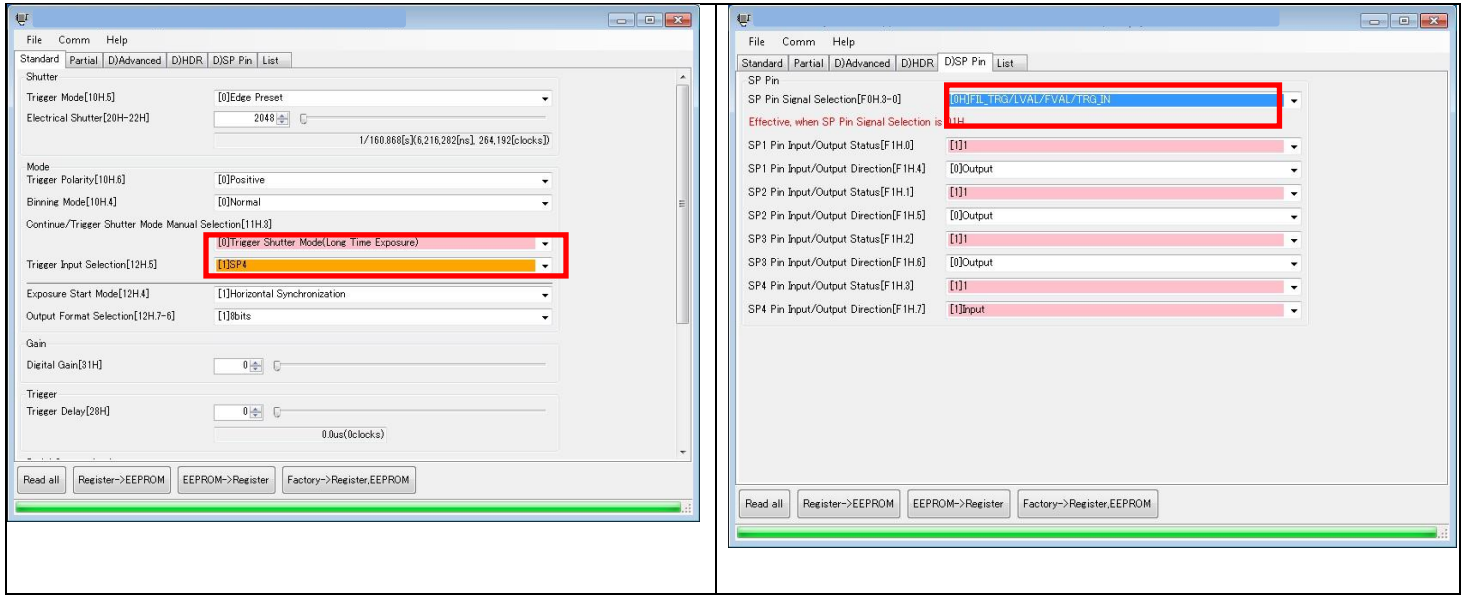

SP\_Pin Signal Selection Table

Pin No	5	4	3	2
Addr=F0	SP1	SP2	SP3	SP4
0	AfterTrigger FILTER	LVAL	FVAL	Trigger Input
1	F1h.0	F1h.1	F1h.2	F1h.3
2	CC1	T_EXP1	FRAME_REQ	HIGH in Exposure
3	CC1	T_EXP1	FRAME_REQ	FVAL
4 ~ 15	Reserved			



## B. Example Setting of AOI

Ex:

Setting on 8 TAP (2048 Pixel)

Variable partial

Variable Partial Start Line[24H,25H]	384	
Variable Partial Effective Line[26H,27H]	320	
Variable Partial Start Line2[15H,16H]	896	
Variable Partial Effective Line2[17H,18H]	256	
Variable Partial Start Line3[19H,1AH]	1344	
Variable Partial Effective Line3[1BH,1CH]	512	
Variable Partial Start Line4[40H,41H]	0	
Variable Partial Effective Line4[42H,43H]	0	
Variable Partial Start Line5[50H,51H]	0	
Variable Partial Effective Line5[52H,53H]	0	
Variable Partial Start Line6[90H,91H]	0	
Variable Partial Effective Line6[92H,93H]	0	
Variable Partial Start Line7[94H,95H]	0	
Variable Partial Effective Line7[96H,97H]	0	
Variable Partial Start Line8[98H,99H]	0	
Variable Partial Effective Line8[9AH,9BH]	0	
Image Width(Horizontal AOD)[29H,7-4]	0	
Horizontal Start Position[4CH,4DH,2-0]	88	
Horizontal Effective Pixel[4EH,4FH,2-0]	80	
Select Lval[4DH,7]	[0]DVAL	

e.g.

The value of the horizontal effective pixel. The horizontal effective pixels of changeable DVAL for each setting.

TAP Number = 8

H\_STRAT; Horizontal Start Position = 704

H\_NUMBER; Horizontal Available Pixel Number = 640

The Horizontal Effective Pixel

Register[4CH,4DH,2-0] =  $704 \div \text{TAP Number} \div \text{Binning or Subsampling number} = 704 \div 8 \div 1 = 88$

The Horizontal Effective Pixels of Changeable DVAL

Register[4EH,4FH,2-0] =  $640 \div \text{TAP Number} \div \text{Binning or Subsampling number} = 640 \div 8 \div 1 = 80$

Mode(29H)	The horizontal effective pixel	The horizontal effective pixels of changeable DVAL	TAP Number	Binning or Subsampling number	Horizontal Pixel	
0	352	320	2	1	2048	Progressive
1	176	160	4	1	2048	Progressive
2	88	80	8	1	2048	Progressive
3 *	70	64	10	1	2040	Progressive
4	352	320	2	1	2048	Progressive
5	352	320	2	1	1024	Progressive
6	352	320	2	1	512	Progressive

7	176	160	4	1	1024	Progressive
8	176	160	2	2	2 x 2	Binning
9	88	80	4	2	2 x 2	Binning
10	88	80	2	4	4 x 4	Binning
11	88	80	1	8	8 x 8	Binning
12	176	160	2	2	2 x 2	Subsampling
13	88	80	4	2	2 x 2	Subsampling
14	88	80	2	4	4 x 4	Subsampling
15	88	80	1	8	8 x 8	Subsampling

Note: Horizontal pixel is 2040 on 10 TAP mode, then formula of "The Horizontal Effective Pixel" is different.

The Horizontal Effective Pixel

Register[4CH,4DH2-0] = (Horizontal start position -4) ÷ 10 TAP ÷ 1

## Revisions

Revision	Date (D/M/Y)	Changes	Changes
0.02	July 11, 2011	Created Document	
0.03	Oct. 24, 2011	Update Changed the dimension drawing Added the LED information	
0.04	Feb 6, 2012	Update Changed the noise level, digital gain, power consumption, dimensions and weight Deleted the 12-bit output	
0.10	Feb 6, 2013	Update Electronic Specifications Spectral Sensitivity Medium / Full Configuration	
0.11	March 6, 2013	Update Added Input / Output signal Circuit	
2.0	May 7, 2013	New Document Updated to Full Version	
2.01	May 20, 2013	Update Revised IO Information	
2.02	May 20, 2013	Update Revised 12H [5]	
2.03	June 5, 2013	Update Revised Frame Rates on Specifications	
2.04	July 16, 2013	Update Added Pixel Defect Correction on D8H	

**Sensor Technologies America, Inc.**

1345 Valwood Pkwy, Suite 320  
Carrollton, Texas 75006-6891  
TEL (972) 481-9223 FAX (972) 481-9209  
URL <http://www.sentechamerica.com/>

**Sensor Technology Co., Ltd.**

7F, Harada Center Building  
9-17, Naka cho 4chrome  
Atsugi-city, Kanagawa  
243-0018 Japan  
TEL +81-46-295-7061 FAX +81-46-295-7066  
URL <http://www.sentech.co.jp/>

**Taiwan Sensor Technology, Inc.**

3F-6, No. 9, Aiguo W, Rd., Jhong Jheng District  
Taipei City 100, Taiwan, R.O.C.  
TEL 886-2-2383-2331 FAX 886-2-2370-8775  
EMAIL: [sentech0501@yahoo.com.tw](mailto:sentech0501@yahoo.com.tw)